



Dr. Pablo Echarri

Dr. Pablo Echarri has developed the clinical bases of the modern CA® CLEAR ALIGNER therapy. After many years of experience and study of the CA® CLEAR ALIGNER system, a technique allowing the minimally invasive treatments of malocclusions with predictable results and reduced treatment time is achieved.

The principles of treatment, clinical and set-up protocols are established, as well as tables of maximal movements.

The bases of his CSW (Custom-made Straight Wire) Technique, his PST (Progressive Stripping Technique), and his PTMA (Plan, Treat, Monitor, Activate) philosophy are integrated in the sequential CA® appliances.

In this second book:

- The treatment protocol has been updated, and some new materials and instruments are included: transverse expansion screw VECTOR® 40 and 50, oblique-lateral expansion screw VECTOR® 30 with CA® Arch, CA® Distalizer Kit with VECTOR® 350 screw, new pliers CA® TIP 3 and 4, CA® POWER GRIP Set with new CA® POWER GRIP n° 8 and n° 9, and Echarri PST (Progressive Stripping Technique) Set.
- CA® DIGITAL System procedure is explained.
- Complete orthodontic treatments procedure is explained, including extraction and distalization treatments (CA® CLEAR ALIGNER “PROFESSIONAL” 7-7 treatment).
- Preprosthetic treatments procedure is explained (CA® CLEAR ALIGNER “PREPROSTHETIC” treatment).

This book is a supplement of the first book and it broadens therapeutic possibilities of the system, establishing the “state of art” of CA® technique.

CA CLEAR ALIGNER ADVANCED

Pablo Echarri

CA CLEAR ALIGNER ADVANCED

CA DIGITAL

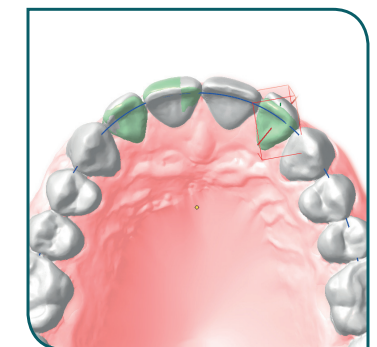

CA LAB

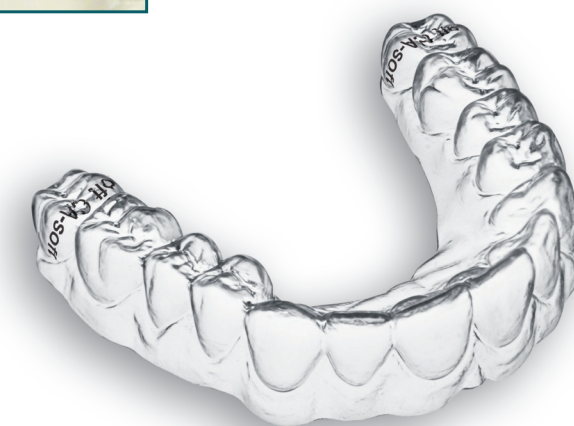
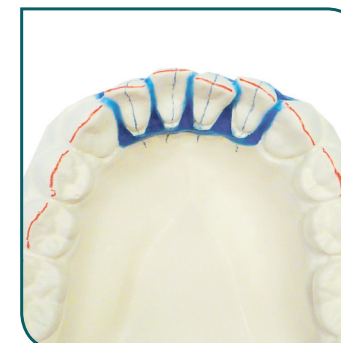



CLEAR ALIGNER ADVANCED

Dr. Pablo Echarri

Collaborators:

Dr. Miguel Ángel Pérez Campoy
Dr. Martín Pedernera

Data sheet

National Library Cataloguing-in-Publication Data

CA CLEAR ALIGNER Advanced / Pablo Echarri Lobiondo - 1º Edition - (Barcelona); Ladent S.L., D.L. 2016; 256 p. il.; 21 X 29,7 cm.

ISBN-13: 978-84-608-6207-9

1. Oral Health 2. Preventive dentistry 3. Orthodontics 4 Dentistry.

Author: Pablo Echarri Lobiondo

Layout, illustrations and design: Julio Blasco Oliete

Translation to English: Nataša Pešić

© 2016, LADENT, S.L.

Lleó 11-13 - 08911 Badalona (Barcelona)

Phone: +34 933 844 705

www.centroladent.com

Legal Deposit: B 6382-2016

ISBN-13: 978-84-608-6207-9

Printed in Spain by QUASAR SERVEIS D'IMATGE

Phone: +34 934 300 230

All rights reserved. No part of this publication may be reproduced, stored in a retrieval system, or transmitted, in any form by any means, electronic, mechanical, photocopying, recording, or otherwise, without prior permission in written from the publisher.

The authors are responsible for the consequences of any copyright violation to third parties, for violation of any relevant agreements or any juridical responsibility in relation with their respective contributions. Publisher and a Publishing company will not be responsible for any copyright violations of the author or other pertinent agreements.

Dedicated to:

Our families, for their unconditional support.

Prologue

Dr. Pablo Echarri has developed the clinical bases of the modern CA® CLEAR ALIGNER therapy. After many years of experience and study of the CA® CLEAR ALIGNER system, a technique allowing the minimally invasive treatments of malocclusions with predictable results and reduced treatment time is achieved.

The principles of treatment, clinical and set-up protocols are established, as well as tables of maximal movements.

The bases of his CSW (Custom-made Straight Wire) Technique, his PST (Progressive Stripping Technique), and his PTMA (Plan, Treat, Monitor, Activate) philosophy are integrated in the sequential CA® appliances.

In this second book:

- The treatment protocol has been updated, and some new materials and instruments are included: transverse expansion screw VECTOR® 40 and 50, oblique-lateral expansion screw VECTOR® 30 with CA® Arch, CA® Distalizer Kit with VECTOR® 350 screw, new pliers CA® TIP 3 and 4, CA® POWER GRIP Set with new CA® POWER GRIP n° 8 and n° 9, and Echarri PST (Progressive Stripping Technique) Set.
- CA® DIGITAL System procedure is explained.
- Complete orthodontic treatments procedure is explained, including extraction and distalization treatments.
- Preprosthetic treatments procedure is explained.

This book is an update of the first book and it broadens therapeutic possibilities of the system, establishing the “state of art” of CA® technique.

The Chapter 1 is an introduction to the CA® CLEAR ALIGNER Technique including the PTMA concept.

The Chapter 2 is an update of treatment protocols including possible variations of the basic protocol when CA® Pliers, CA® POWER GRIP Set or VECTOR® screws are used. The reasons for these protocols are also explained.

It is also explained how to use the new CA® SMART 4.0 software, as well as the new hardware designed for it.

The Chapter 3 is a step by step explanation of the use of VECTOR® screws used for transverse expansion, oblique-lateral expansion and distalization. In the Chapter 4, the use of CA® POWER GRIP Set is explained in detail, and in the Chapter 5, the CA® Pliers use. In this way, these three chapters explain the use of the new armamentarium of the technique, including the new products.

The Chapter 6 explains the space closure treatments both by incisors retroclination and incisors mesialization using the CA® POWER GRIP n° 2 and n° 3, and the Chapter 7 develops the crowding treatment with VECTOR® 40 and 50 screws for transverse expansion, VECTOR® 30 screw with CA® Arch, and Echarri PST Set.

The Chapters 8 and 9 are dedicated to the CA® DIGITAL system, and they explain the protocol for treatment acceptance and aesthetic treatments in anterior teeth. CA® CLEAR ALIGNER “PROFESSIONAL” 7-7 treatments and preprosthetic treatments are studied in the Chapters 10 and 11.

The Chapter 12 is dedicated to an update of CA® CLEAR ALIGNER treatments combined with fixed appliances. The Chapters 13 and 14 expose the instructions which specialists and patients should follow in order to obtain the maximum benefits of the technique.

We wish this book to be as useful and practical as the first CA® CLEAR ALIGNER book, hoping it will be of help for specialists and laboratories dedicated to this technique.

Dr. Pablo Echarri

Chapter 1 - Introduction to the CA® CLEAR ALIGNER technique. PTMA Circle. O2U concept. CA® LAB and CA® DIGITAL	13
Introduction to the CA® CLEAR ALIGNER technique. PTMA Circle.....	11
O2U concept: “Orthodontics to You”.....	16
CA® LAB and CA® DIGITAL.....	17
Chapter 2 - CA® CLEAR ALIGNER. Treatment protocol	19
Introduction.....	21
Biological bases of CA® CLEAR ALIGNER treatment protocol.....	21
Protocol of CA® CLEAR ALIGNER insertion.....	26
CA® CLEAR ALIGNER types	29
Laboratory protocol.....	40
Maximal dental movements.....	51
Chapter 3 - Expansion screws VECTOR® for CA® CLEAR ALIGNER	55
Expansion screws VECTOR® for CA® CLEAR ALIGNER.....	57
VECTOR® 40 Screw.....	57
VECTOR® 50 Screw.....	58
VECTOR® 30 Screw with CA® Arch	58
CA® Distalizer Kit + VECTOR® 350.....	59
VECTOR® Screws use protocol.....	60
Chapter 4 - CA® POWER GRIP Set	61
Introduction.....	63
CA® Plastic Buttons.....	66
CA® POWER GRIP 1 - MFM - Multifunctional Forced Movement	70
CA® POWER GRIP 2 - MDI - Mesial/Distal Inclination and CA® POWER GRIP 3 - DMI - Distal/Mesial Inclination.....	93
CA® POWER GRIP 4 - FALA - Force Application Labial and CA® POWER GRIP 5 - FALI - Force Application Lingual.....	98
CA® POWER GRIP 6 - BUB - Build-Up Bicuspid and CA® POWER GRIP 7 - BUM - Build-Up Molar.....	103
CA® POWER GRIP 8 - BUAS - Build-up Anterior Small and CA® POWER GRIP 9 - BUAL - Build-up Anterior Large.....	110
Chapter 5 - CA® Pliers for CA® CLEAR ALIGNER activation	123
Introduction.....	125
CA® TIP 1.....	126
CA® TIP 2.....	127
CA® TIP 3.....	128
CA® TIP 4.....	129
Clinical protocol for the use of CA® TIP 2, 3 and 4.....	131
Summary of the CA® Pliers use.....	132
Chapter 6 - CA® CLEAR ALIGNER “AESTHETIC” 3-3. Space closure treatment	133
Introduction	135
Protocol for the space closure treatment in the incisor-canine zone with incisors retroclination.....	136
Space closure in molar zone	145
Relapse space closure in extraction cases.....	145
Chapter 7 - CA® CLEAR ALIGNER “AESTHETIC” 3-3. Crowding treatment: Expansion and stripping ..	147
Introduction	149
Expansion	150
Stripping	152
Treatment time	160

Chapter 8 - CA® DIGITAL. Treatment plan. Acceptance of the treatment plan	161
Introduction	163
Acceptance of the treatment	163
Chapter 9 - CA® DIGITAL-Aesthetic: Spacing and crowding in anterior teeth	167
Introduction	169
Spacing treatment in anterior teeth.....	169
Crowding treatment.....	171
Standard protocol in spacing or crowding treatment with CA® DIGITAL	172
CA® CLEAR ALIGNER “ESSENTIAL” 5-5	172
Chapter 10 - CA® CLEAR ALIGNER “PROFESSIONAL” 7-7 treatment	173
Introduction	175
Class I malocclusion with mild crowding and Bolton discrepancy treated with stripping.....	175
Class I malocclusion with mild crowding and without Bolton discrepancy treated with oblique-lateral expansion	176
Class I malocclusion with severe crowding treated with extractions	177
Class I malocclusion with transverse discrepancy treated with transverse expansion	185
Class I malocclusion with anterior deep bite treatment	189
Class I malocclusion with anterior open bite treatment	192
Class II malocclusion treatment with distalization.....	196
Class II malocclusion treatment with extractions.....	198
Class III malocclusion treatment with distalization.....	198
Class III malocclusion treatment with extractions.....	198
Combination of treatments.....	189
Chapter 11 - CA® CLEAR ALIGNER “PREPROSTHETIC” treatment	199
Introduction	201
Space maintainer	201
Space gainer	201
For diagnosis	201
Temporal esthetic restoration.....	203
Preprosthetic treatment.....	203
Chapter 12 - Treatment combined with fixed appliances	215
Introduction	217
CA® CLEAR ALIGNER before fixed appliances	219
CA® CLEAR ALIGNER and fixed appliances in the antagonist jaw.....	221
CA® CLEAR ALIGNER after fixed appliances	221
First, second and third order adjustments	222
Intermaxillary adjustments	223
Chapter 13 - Instructions for the patient	229
Instructions for CA® CLEAR ALIGNER patients	231
Chapter 14 - Instructions for the doctor	235
How to start a treatment with CA® CLEAR ALIGNER	227
Recommended bibliography	253

Introduction to the CA® CLEAR ALIGNER technique. PTMA Circle

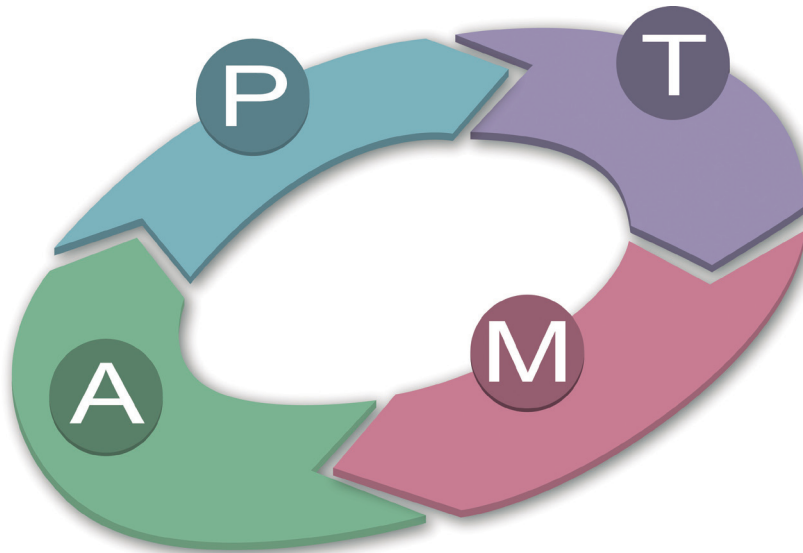

Fig. 1. Plan, Treat, Monitor, Activate. To plan, carry out the Treatment, Monitor and Activate the treatment according to the monitoring result.

The sequential processes of fabrication or treatment i.e., those processes which require carrying out the sequence of various procedures, can easily accumulate errors. Because of this, if all steps are carried out, but only the final product is evaluated, many defective products are obtained. In the clinic, we'll face with the fact that not all treatment objectives are achieved, and it is necessary to carry out an additional treatment in order to achieve the desired position of all teeth.

The Demming Circle for continuous quality control during the sequential processes is: PDCA (Plan, Do, Check, Act) i.e., we should plan, do, check and act according to the results o control. In this way, the continuous quality control is achieved, and at the end of the treatment, the desired result is accomplished without any digressions. The Echarrí cycle, PTMA Circle (Plan, Treat, Monitor, Activate) suggests that we should Plan, Treat, Monitor and Activate the treatment according to the monitoring results, and it also allows us to correct the treatment if necessary, having in mind all the possible variables which frequently cannot be completely controlled:

- Real hours of use of aligner.
- Magnitude of chewing forces, which depend on the musculature of a patient, among other factors.
- Other active forces, such as possible habits of lips, cheeks, objects or tongue thrust.
- Biological response of bone to the action of aligner, which depends on the characteristics of periodontal ligament and bone, metabolic factors, patient's age, etc.

Because of all this, CA® CLEAR ALIGNER has developed the usual clinical and laboratory protocol which allows the monitoring of the treatment and the adaptation of its activation to the individual characteristics of a patient through periodical impressions. In his CSW Technique (Custom-made Straight Wire), Dr. Echarrí established the necessity to customize the treatment protocols for each case and the very same philosophy will be applied to CA® CLEAR ALIGNER treatments.

O2U concept: “Orthodontics to You”

O2U (Orthodontics to You) means Orthodontics designed for a patient and it includes treatments carried out with CA® CLEAR ALIGNER and CLO3 Technique (Custom-made Lingual Orthodontics in 3 steps).

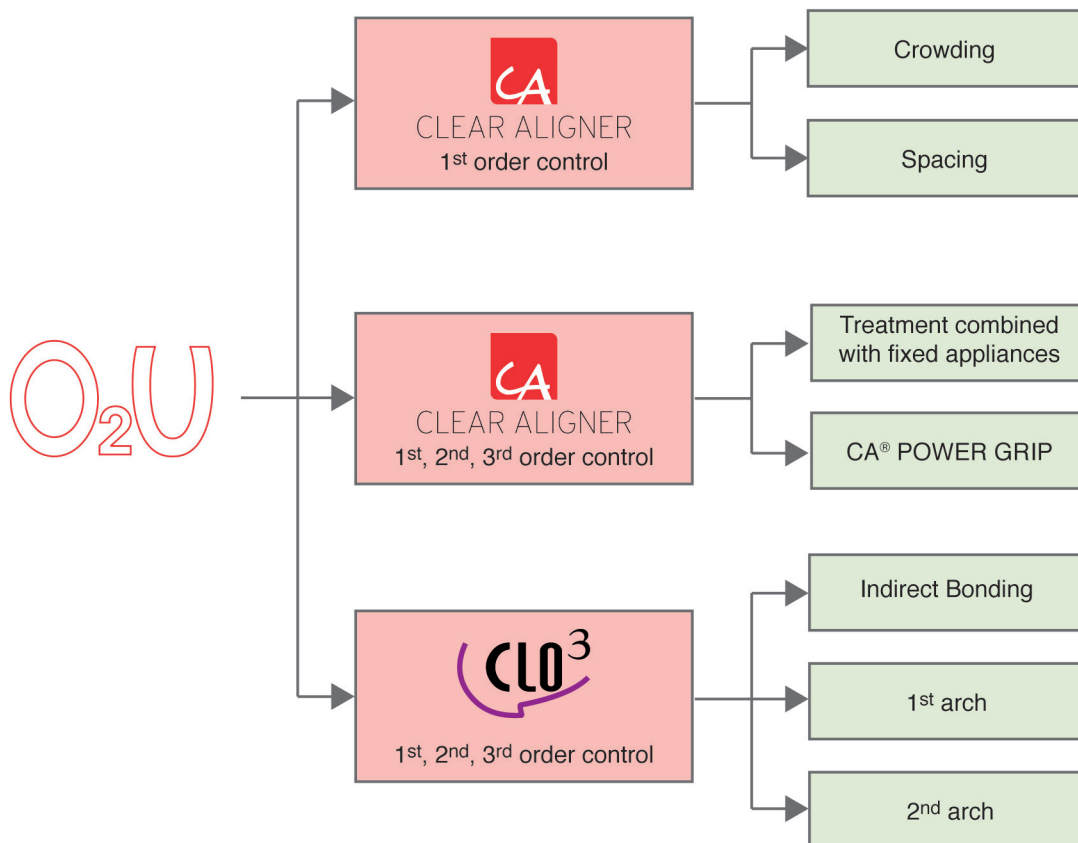

Fig. 2. O2U Scheme.

CA® CLEAR ALIGNER appliances allow the accurate control of alignment, leveling and correction of rotations, i.e., the first order problems, although for some of these movements, such as extrusion or rotation control, additional retention in teeth, carried out with CA® POWER GRIP, may be needed.

For second order control (mesio-distal inclination), or third order control (bucco-lingual inclination), the use of additional retention in teeth carried out with CA® POWER GRIP is necessary, or CA® CLEAR ALIGNER treatments should be combined with fixed appliances treatments, which will be studied later.

The CLO3 Technique is specifically designed for those patients who present malpositioned incisors and/or canines, but correct occlusion of posterior teeth. The treatments are short (4 to 6 months), carried out with lingual brackets bonded from first bicuspid to first bicuspid. The laboratory prepares the CLO3 Kit which includes brackets, transfer trays and two arch wires necessary for this type of treatments. The description of this technique is out of scope of this text, but there are numerous articles listed in References at the end of this book which will allow you to get familiar with the technique.

CA® LAB and CA® DIGITAL

The principles of CA® CLEAR ALIGNER Technique are the same both in digital or analog procedure.

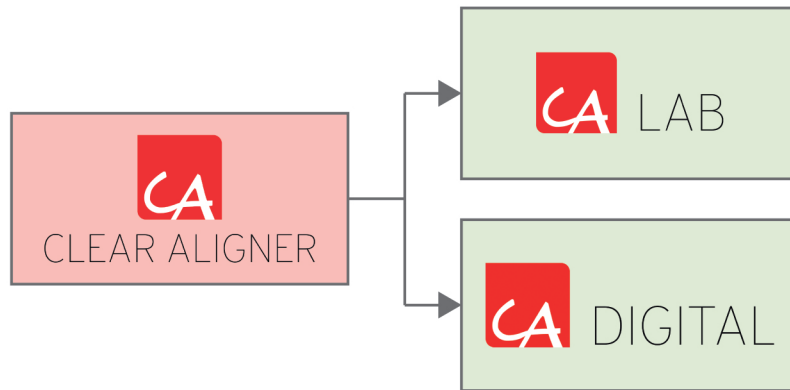

Fig. 3. CA® LAB and CA® DIGITAL Scheme.

The CA® LAB system uses CA® SMART and CA® CHECKER, and the set-up models are carried out manually over the plaster models, as we'll see later.

The CA® DIGITAL procedure is carried out starting from the digital models obtained from digital impressions or from plaster model scanning, the fabrication of virtual set-up models, and digital impression of set-up models.

The aligners can be formed over the plaster set-up models or over digitally printed set-up models.

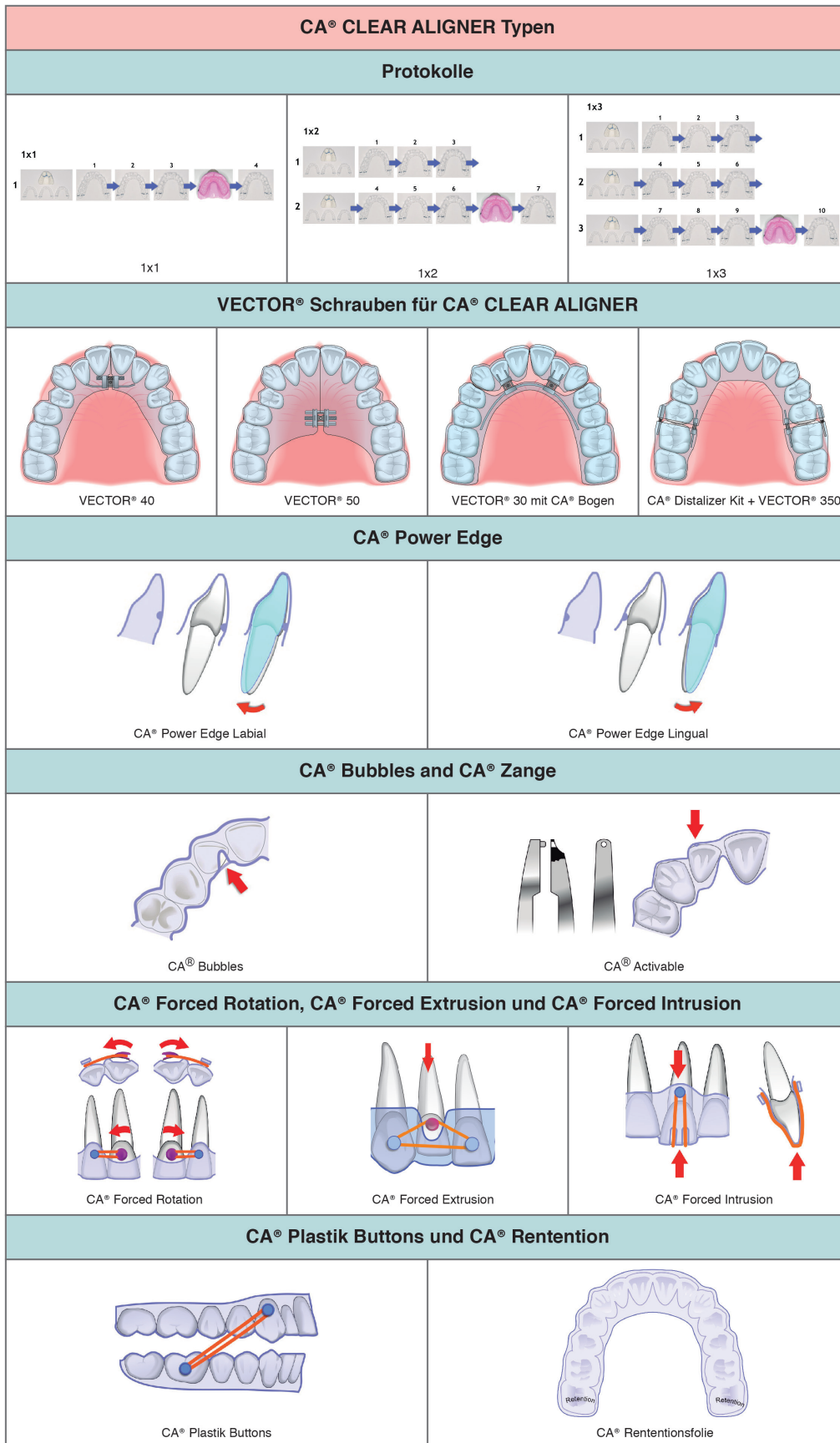

Fig. 18.