



## Catalogue

- // Clasps and Bars
- // Orthodontics
- // CA® CLEAR ALIGNER
- // CAD / CAM
- // Dental Sleep Medicine
- // Pressure Moulding Technique
- // Laboratory Equipment



# Contents

## Clasps and bars

N-Clasp	18	TK-Clasp	19	PROFI Bar	21
NK-Clasp	18	J-Clasp	19	Jaw fracture splint	21
O-Clasp	18	J-Clasp oblique	20	Lingual bar	21
OK-Clasp	18	JM-Clasp	20		
T-Clasp	19	SCHEU-Anchor	20		

## Orthodontics

SCHEU-Anchor	24	CARAT® Aderer pliers medium	29	BLUE-BLOKKER®	41
Adams Clasp	24	CARAT® Angle pliers (HM)	29	Hinge system acc. to Herbst	43
Triangle Clasp	24	CARAT® Flat pliers	29	Fastening elements for Herbst appliance	43
Arrow Clasp	25	CARAT® Crampon pliers	30	Distance rings	43
Coffin spring	25	CARAT® Young pliers	30	Hinge 44 kit	44
Frontal guiding bars acc. to Hinz	25	Ortho arch bender	30	Fastening elements with retention	44
U-Bar acc. to Karwetzky	25	VECTOR® screws and accessories	31–36	Activator tubes	44
MENZANIUM® Coil wire	26	STEADY-RESIN	37–39	Activator tubes acc. to Teuscher	44
MENZANIUM® Wire rods	26	Mica	39	Silicone tube	45
CHROMIUM Coil wire	27	RESIMIX®	39	Symmetry measurement gauge	45
CHROMIUM Wire rods	27	IMPRIMO® Model Separator	40	Angle tester acc. to Adamik	45
Quad Helix	28	3D Model insulation	40	CETRON®	46–47
Lingual/palatal sheath	28	Orthodontic insulating agent	40	Retainer boxes	47
CARAT® Aderer pliers large	29	Set-up technique	41–42		

## // CA® CLEAR ALIGNER

CA® Foil	50	CA® TIP pliers	53–54	CA® FLASH	57
CA® Pro	50	CA® Strip Opener	55	CA® POWER GRIP set	58
CA® Pro+	50	CA® Stripping Tool	55	CA® Plastic buttons	58
CA® Retention foil pd	51	Stainless steel holder	56	CA® Cyano Veneer Fast	58
VECTOR® 30	51	ECHARRI PST Set	56	CA® Pipettes	58
VECTOR® 40 acc. to Prof. Hinz	51	CA® Gauge	56	CA® Coloured pencils	58
VECTOR® 45 / 45 M acc. to Prof. Hinz	52	CA® Splint bags	57	Splint Remover	59
CA® Distalizer kit acc. to Dr. Echarri	52	CA® Splint case for patients	57	ECHARRI Template kit	59
TFA-Kit acc. to Dr. Echarri	52	CA® Travel Case	57	CA® literature	59

## // CAD / CAM

Asiga MAX™	62	IMPRIMO® Model Separator	66	IMPRIMO® LC Gingiva	69
Asiga PRO 4K	63	3D Model insulation	66	IMPRIMO® LC Try-In	69
Asiga MAX™ Tray	64	IMPRIMO® LC Model	67	IMPRIMO® LC Denture	69
Tray Box Asiga MAX™	64	IMPRIMO® LC Splint	67	IMPRIMO® LC Temp	70
Asiga PRO Tray	64	IMPRIMO® LC Splint flex	67	IMPRIMO® LC Temp It	70
RS wash	65	IMPRIMO® LC Impression	68	IMPRIMO® LC MJF	70
RS cure	65	IMPRIMO® LC IBT	68	DURASPLINT® flex	71
IMPRIMO® Cleaning Liquid	66	IMPRIMO® LC Cast	68		

## // Dental Sleep Medicine

IST® Kit HF 9	74	TAP® PAP	78	GEORGE GAUGET™ bite registration set	83
Telescopes	74	TAP® PAP Lower Tray	78	AM Aligner	83
IST® fastening elements and positioning aid	74–75	myTAP™	79	Occlusion trainer	83
OPM Kit	75	TAP® Splint case for patients	79	CETRON® Care set	84
TAP® Standard Kit	76	TAP®-T Mounting device	79	CETRON® Care spray	84
TAP®-T Kit	76	TAP®-T Matrix	79	CETRON® Cleaning powder	84
TAP®-T Reverse Kit	77	TAP® components	80–81	CLEAR-BLOKKER®	85
TAP®-T Starter-Set	77	Bite Fix®	82	Activation key	85
TAP®-T Reverse Starter-Set	77	Bite Fix® Scan	82		
dreamTAP™	78	Bite Fix® One	82		

## Pressure Moulding Technique

<b>Pressure moulding material</b>					
BIOCRYL® C	88	IMPRELON® S pd	98	OSAMU-Bond	105
BIOCRYL® Form X	88	OSAMU-Retainer® Kit	98	Impression tray handles	105
DURAN®	89	COPYPLAST®	99	Foam discs	105
DURAN®+	89	COPYPLAST® C	99	Stainless steel pellets	106
DURAN®+ A2 pd	90	HARDCAST®	99	Pellet cover	106
DURAN®+ white pd	90	ISOFOLAN®	100	Pellet brush	106
CA® Pro	91	Spacer foil	100	Model platform 85 mm	106
CA® Pro+	91	Skin packaging	100	Heating support	106
CA® Foil	92	Coating foil	100	SD-Foil scissors A	107
CA® Retention foil pd	92	<b>Accessories</b>		SD-Foil scissors B	107
DURASOFT® pd	93	Sampler of pressure moulding material	101	Finishing set	107
DURASOFT® blue pd	93	BLUE-BLOKKER®	102	LC-Bur	108
DURASOFT® seal	94	CLEAR-BLOKKER®	102	Finishing bur	108
BIOPLAST®	94	Cannula	102	HM-Tricutter fine	108
BIOPLAST® bleach	95	SIL-KITT	102	HM-Carbide cutter	108
BIOPLAST® Color	95	Blocking-out putty	103	Cutting bur	108
BIOPLAST® Multicolor	96	BIOPLAST® Insulating agent	103	OSAMU Polisher	109
BIOPLAST® XTREME	96	BIOCRYL® Resin	103	POLYFIX	109
BIOPLAST® XTREME Kit	97	DURASPLINT®	103	BIOPERM Trimmer	109
BIOPLAST® XTREME PRO Kit	97	DURASPLINT® flex	104	DIMO®	109
BRUX CHECKER® acc. to Prof. Sato	97	DURASPLINT® LC	104	DIMO®PRO	109
IMPRELON®	98	LC Primer	105	DIMO®PRO SLIM	109
		LC Insulation	105		

## Laboratory equipment

Asiga MAX™	112	RS cure	114	Model holder	118
Asiga MAX™ Tray	112	LC-6 Light Oven	115	Parallelometer	118
Tray Box Asiga MAX™	112	BIOSTAR®	116	Split-Fixator	119
Asiga PRO 4K	113	BIOSTAR® Protection cover	116	Hinge fixator	119
Asiga PRO Tray	113	MINISTAR S®	117	Mounting rails	119
RS wash	114	MINISTAR S® Protection cover	117		

## Appendix

Indication chart on pressure moulding applications	120–121	Indication chart for aligner material	124	Product index by REF number	126–129
Technical properties of IMPRIMO® LC resins	122–123	Expansion parameters of VECTOR® screws	124		
		Material lists and measuring units	125		



# Welcome to SCHEU-DENTAL

Exit 46  
Iserlohn-Oestrich

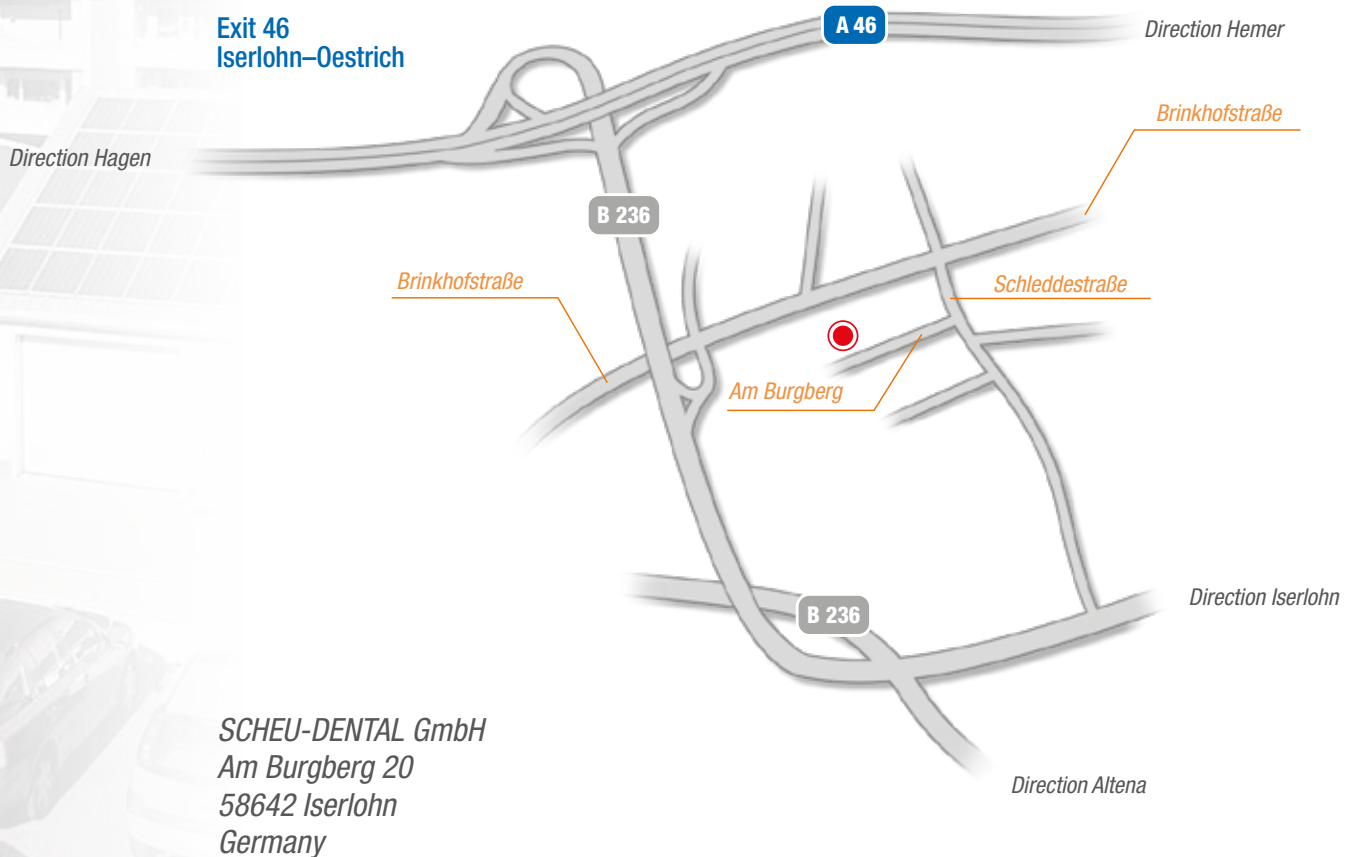

1. Motorway A45, at Hagener Kreuz  
→ A46 Direction Iserlohn
2. Exit 46  
→ Iserlohn – Oestrich
3. Please turn left after 200 m  
→ Direction Oestrich
4. Please turn right at the roundabout  
→ Gewerbegebiet Burgberg
5. Please turn right after 600 m  
→ Schleddestraße
6. Please turn right immediately again  
→ Am Burgberg





# Join us in the digital workflow.

**For years, we have observed that clinical and dental processes in orthodontics are about to change fundamentally:** What begins with intra-oral scanning and continues with virtual diagnostic assessment and digital treatment planning for aligners, is accomplished by an additive manufacturing process completing the circle with the actual therapy on the patient.

The dynamics allowing to replace long proven manual working steps by digital ones is about to significantly change our professional world and offers possibilities to develop new competences. Our vision is to contribute to and to shape this exciting development so that you, the user, can benefit from the efficient work processes that are made possible by these new technologies – at manageable risk.

Our approach is simple: new technologies involve considerable investments for all participants – associated with entrepreneurial uncertainties. So why not spread the risks over more than one shoulder and address them step by step? SMART FLOW offers you the option to complement proven treatment approaches with innovative technologies – at your own pace and according to your personal preferences. You can access the digital workflow at any point, determine the individual level of your digitalisation for yourself or have digital planning and production provided externally by our service company CA DIGITAL. This enables you to have access to innovative technologies and treatment solutions without having to manage digital manufacturing in your own lab.

The SCHEU GROUP will accompany you on your way to digitalisation not only with individual solutions, but also with excellent service – after all, a technology is just as good as the knowledge of the user. This is why both installation service for technical devices from our field service and reliable support from our application engineers matter to us – by phone, TeamViewer or on site.

**Join us in the digital workflow. We accompany you - as long as you want us to, step by step!**

SMART FLOW



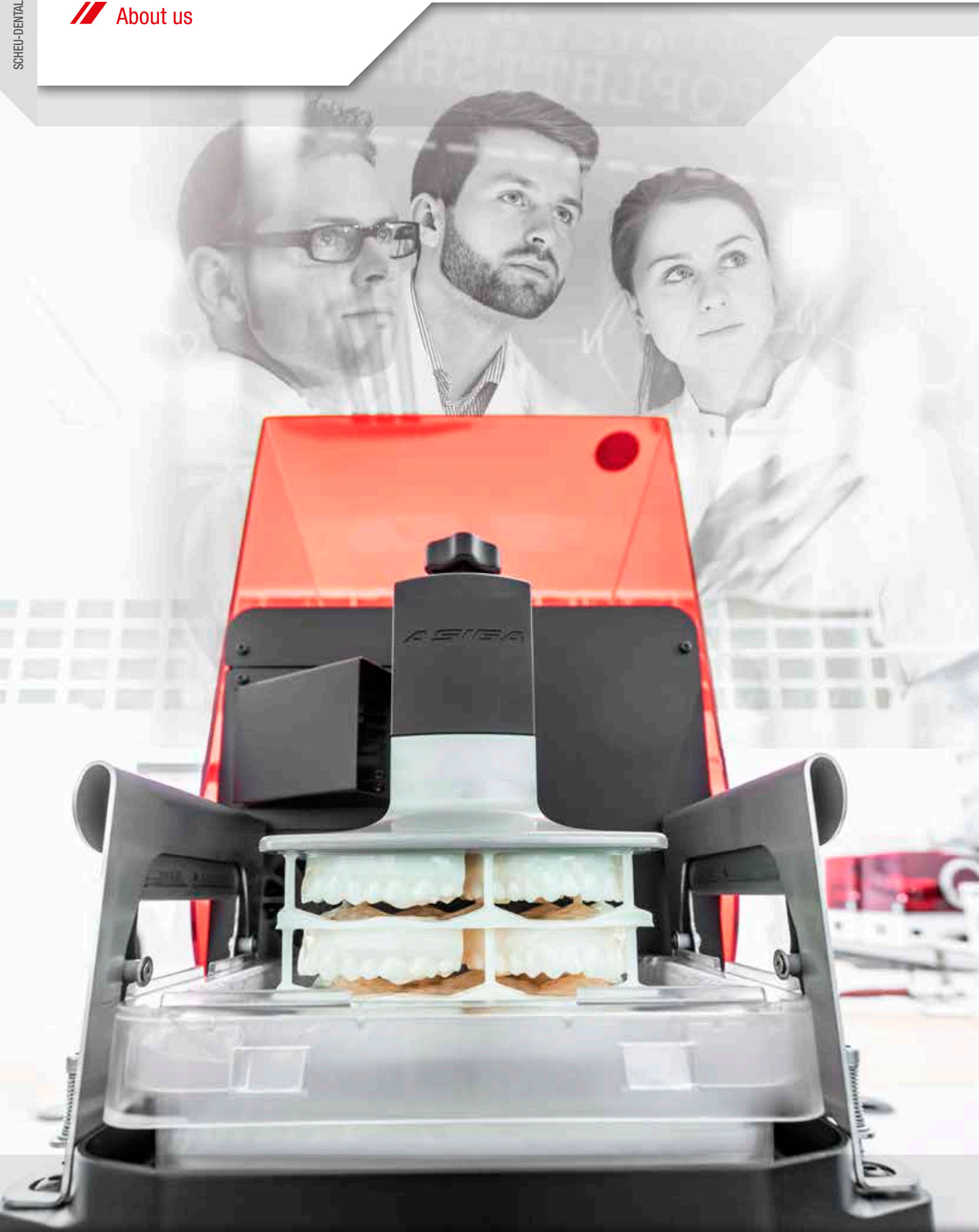

# You must have a vision to shape the future.

**At our Research and Development department we come up with clever ideas designed to lighten the daily workload of the dental laboratory and practice.** Some of these ideas may have no future, but others are already there to enrich your everyday work today. One example is **CA® Pro**, the three-layer material for the aligner production, the result of many years of researching an aligner material with improved properties for the benefit of both, doctor and patient.

Some of the ideas, particularly in the field of digitalisation, even have the potential to fundamentally change your future working life. Take **Asiga PRO 4K** from our Australian partner Asiga: this 3D printer is able to achieve unprecedented production volumes in the shortest possible times – without any quality loss. The **IMPRIMO® LC printer resins**, matched to 3D printers with 385 nm light source, enable you to generatively manufacture print objects for a wide range of dental indications covering the classic working model, occlusal splints and bracket transfer masks as well as temporary crowns and bridges.

What all our ideas have in common: they are accompanied by an excellent service. Our field technicians show you how to operate our thermoforming machines, our application technicians in the lab are there to help you with questions on our products, our scientific employees for the development of new resins assist you with any question you may have around these materials and our experts in sleep medicine are pleased to consult you with manufacturing of anti-snoring devices for patients with problematic occlusion. Our 3D printing application technicians take care of your requests concerning digital technologies – via phone or on-site appointment: If you have questions about a product, you should talk to someone who actually works with it every day – or who has even developed it. This is how you can shape the future and make our visions come true!

**We are there to assist you!**



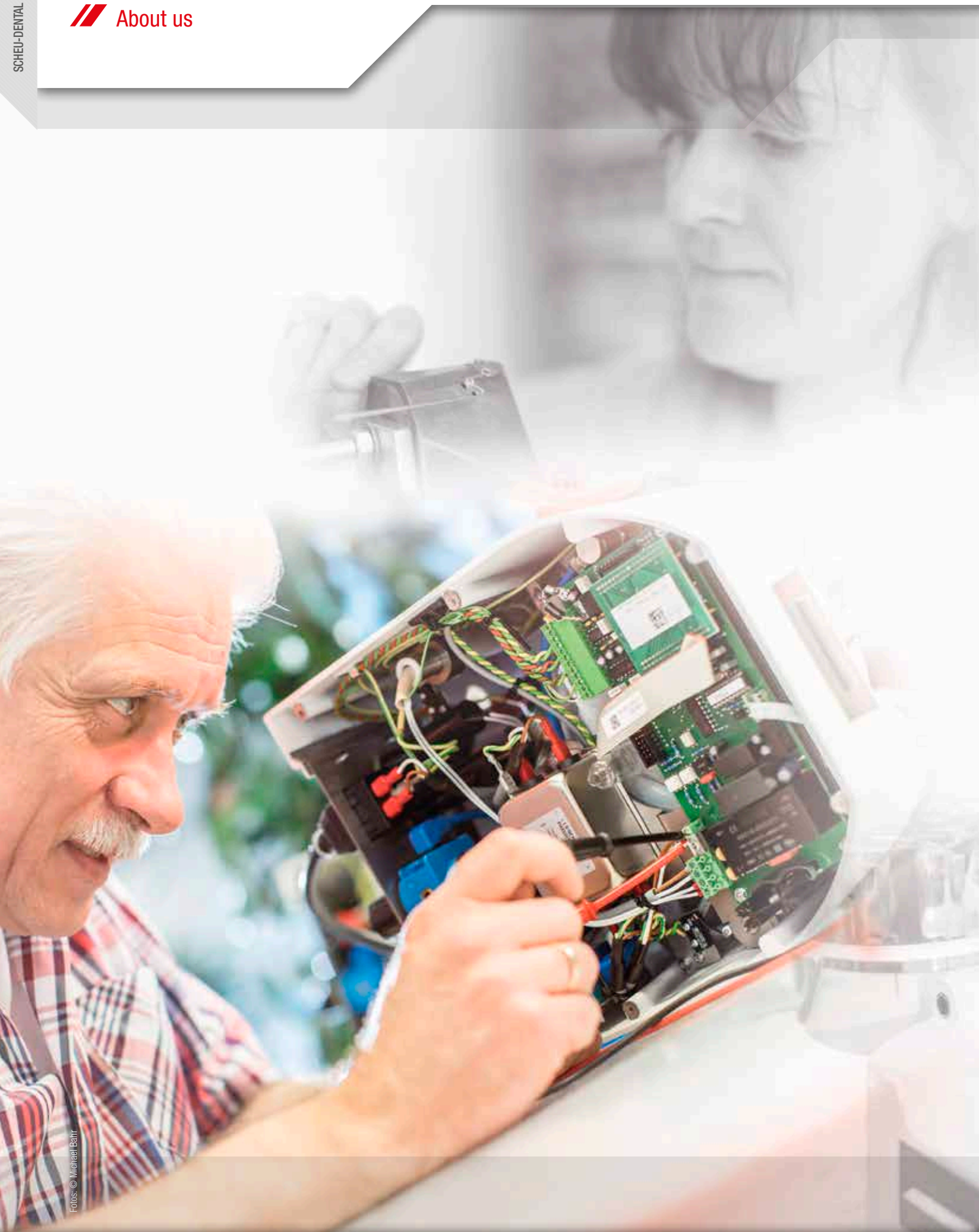

Fotos: © Michael Bairr

# Great attention to detail – even for the tiniest part.

**The realisation of complex precision constructions requires dexterity and experience.** Therefore, many parts at SCHEU-DENTAL are still manufactured by hand, as this is the only way to ensure the greatest possible quality of the precision mechanical parts. The staff at our site makes sure that the company never deviates from these quality standards – regular product controls according to the most recent certification standards included.

Thanks to this enthusiasm and love for details, we were able to establish ourselves as a leader in the field of dental thermoforming and to participate in shaping dental technologies around the world. A confirmation of our work rich in tradition that we are particularly proud of - especially since our products demonstrate their quality today in practices and laboratories in over 100 countries.



**Impressions from  
our production:**





# Service makes the difference.

**It has always been our concern to give you practical advice,** combined with a sound basis in specialist knowledge, whether it comes to personal commissioning your technical devices or to answering concrete questions about their application. Our co-workers in the sales and service department are happy to support you with qualified advice.

And this goes beyond your actual purchase: for some years now, the ACADEMY of the SCHEU GROUP regularly offers training courses and seminars for dentists and technicians including certification courses on CA® CLEAR ALIGNER and TAP® as well as thermoforming workshops and application courses around digital orthodontics. You get to learn by practical applications and in small groups how to achieve even more professional results in the future.

In addition, our field technicians offer dental workshops at your trading partners where you can be trained in pressure moulding technique, bleaching and 3D printing.

Explore our extensive offer on advanced training courses for dental technicians and dentists at [www.scheu-academy.com](http://www.scheu-academy.com) or follow us on facebook to be the first to know about new courses. You are also welcome to make an appointment with our field service – we look forward to meeting you!

**Watch our training videos online:**







# Clasps and bars

For us at SCHEU-DENTAL continuity and quality go hand in hand.

**We have been manufacturing clasps for more than 90 years.**

Based on that experience, our range of clasps and bars has become a benchmark. Made of high-grade stainless steel alloys with excellent resistance to oral conditions, fabricated by cold forming,

from one piece without soldering connections and with highly-polished surface. Our clasps are of excellent elasticity and stability – your patients can trust you.

Clasps.....	18	Bars.....	21
-------------	----	-----------	----

# Clasps

Our clasps are made by cold forming of a stainless steel alloy (material DIN no. 1.4301) with excellent resistance to oral conditions. Highly-polished surface, from one piece without solder connections for optimum elasticity and stability.

Learn more:

## N-Clasp

// Ø 0.9 mm	<b>1009.1</b> 10 pieces	<b>1009.2</b> 100 pieces
// Ø 1.0 mm	<b>1010.1</b> 10 pieces	

CE 0044



## NK-Clasp

// Ø 0.8 mm	<b>1013.1</b> 10 pieces	<b>1013.2</b> 100 pieces
-------------	----------------------------	-----------------------------

CE 0044



## O-Clasp

// Ø 0.9 mm	<b>1002.1</b> 10 pieces	<b>1002.2</b> 100 pieces
// Ø 1.0 mm	<b>1003.1</b> 10 pieces	

CE 0044



## OK-Clasp

// Ø 0.8 mm	<b>1007.1</b> 10 pieces
-------------	----------------------------

CE 0044



## T-Clasp

// Ø 0.9 mm

**1026.1**  
10 pieces

// Ø 1.0 mm

**1027.1**  
10 pieces

CE 0044

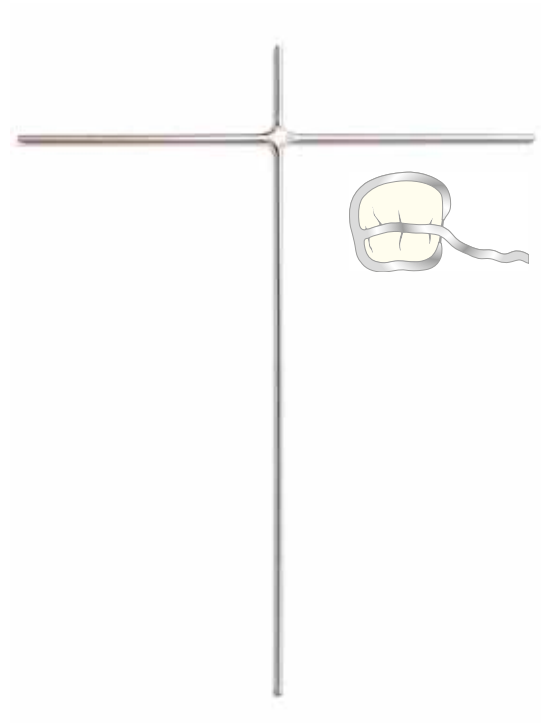

## TK-Clasp

// Ø 0.9 mm

**1029.1**  
10 pieces

**1029.2**  
100 pieces

// Ø 1.0 mm

**1030.1**  
10 pieces

**1030.2**  
100 pieces

CE 0044

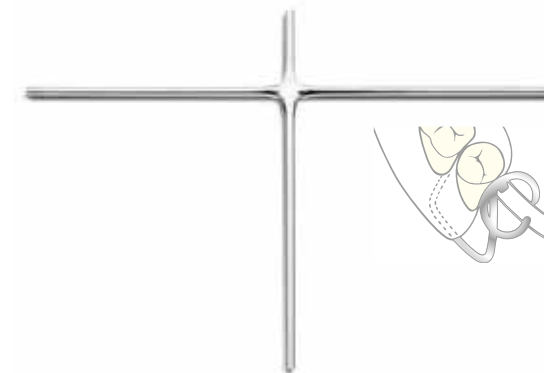

## J-Clasp

// Ø 0.8 mm

**1017.1**  
10 pieces

**1017.2**  
100 pieces

// Ø 0.9 mm

**1018.1**  
10 pieces

**1018.2**  
100 pieces

// Ø 1.0 mm

**1019.1**  
10 pieces

**1019.2**  
100 pieces

// Ø 1.1 mm

**1047.1**  
10 pieces

CE 0044

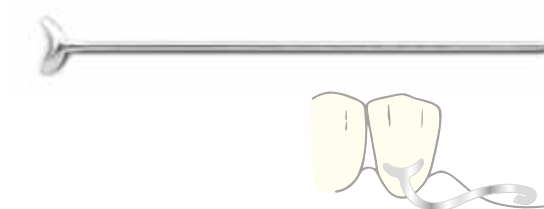

## J-Clasp oblique

∕ ∅ 0.8 mm in pairs (5 left and 5 right)	<b>1020.1</b> 10 pieces	
∕ ∅ 0.9 mm in pairs (5 / 50 left and 5 / 50 right)	<b>1021.1</b> 10 pieces	<b>1021.2</b> 100 pieces
∕ ∅ 1.0 mm in pairs (5 / 50 left and 5 / 50 right)	<b>1022.1</b> 10 pieces	<b>1022.2</b> 100 pieces
∕ ∅ 1.1 mm in pairs (5 left and 5 right)	<b>1048.1</b> 10 pieces	

CE 0044

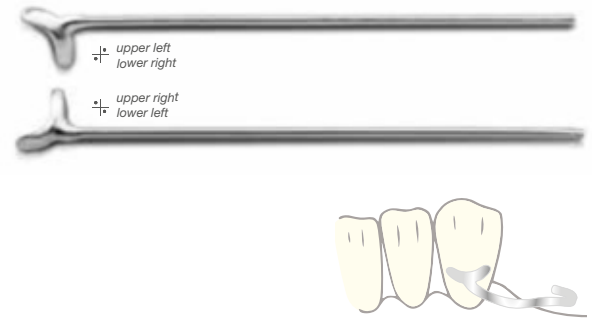

## JM-Clasp

∕ ∅ 1.2 mm	<b>1023.1</b> 10 pieces
------------	----------------------------

CE 0044

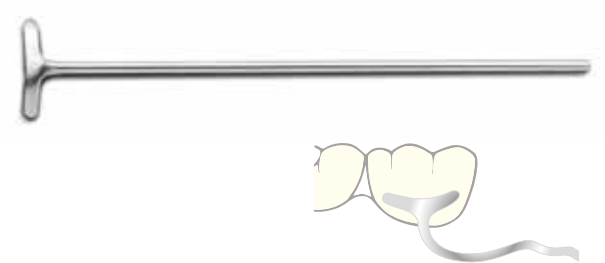

## SCHEU-Anchor

Unique retention and spring force! SCHEU-Anchors consist of stainless steel alloys (material DIN no. 1.4301) with excellent resistance to corrosion and oral conditions.

∕ ∅ 0.6 mm	<b>2048.1</b> 10 pieces	<b>2048.2</b> 100 pieces	
∕ ∅ 0.7 mm	<b>2049.1</b> 10 pieces	<b>2049.2</b> 100 pieces	<b>2049.3</b> 1000 pieces
∕ ∅ 0.8 mm	<b>2050.1</b> 10 pieces	<b>2050.2</b> 100 pieces	<b>2050.3</b> 1000 pieces
∕ ∅ 0.9 mm	<b>2051.1</b> 10 pieces	<b>2051.2</b> 100 pieces	<b>2051.3</b> 1000 pieces
∕ ∅ 1.0 mm	<b>2052.1</b> 10 pieces	<b>2052.2</b> 100 pieces	
∕ ∅ 1.2 mm	<b>2053.1</b> 10 pieces	<b>2053.2</b> 100 pieces	

CE 0044

# Bars

## PROFI Bar

Made of stainless steel alloy (material DIN no. 1.4303, contains nickel) with excellent resistance to oral conditions and highly-polished surface. From one piece without solder connections for optimum elasticity and stability.

// curved, length 80 mm

**1039.1**  
10 pieces

// straight, length 80 mm

**1040.1**  
10 pieces

CE 0044

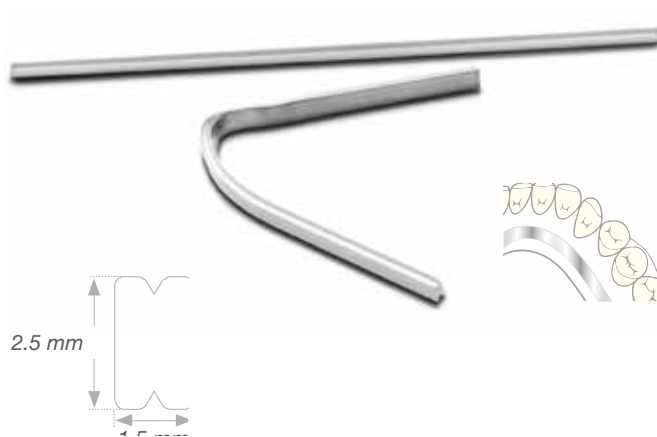

## Jaw fracture splint

Made of stainless steel alloy (material DIN no. 1.4301, contains nickel) with excellent resistance to corrosion and oral conditions, with 20 buttons. MRI incompatible.

// hard, Ø 1.0 mm

**1038.1**  
10 pieces

// soft, Ø 1.0 mm

**1049.1**  
10 pieces

CE 0044

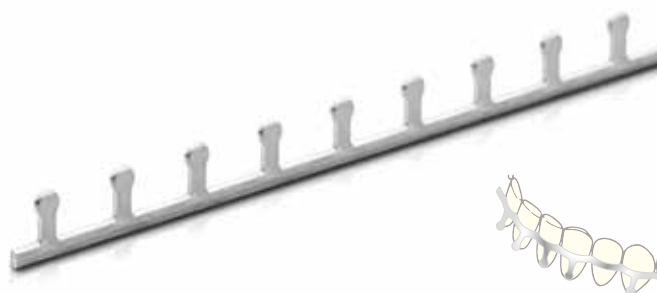

## Lingual bar

Elliptical, hard stainless steel profile (material DIN no. 1.4310), anatomically curved with stamped retentions.

// curved, length 60 mm

**1051.1**  
10 pieces

// curved, length 70 mm

**1052.1**  
10 pieces

// curved, length 80 mm

**1053.1**  
10 pieces

CE 0044

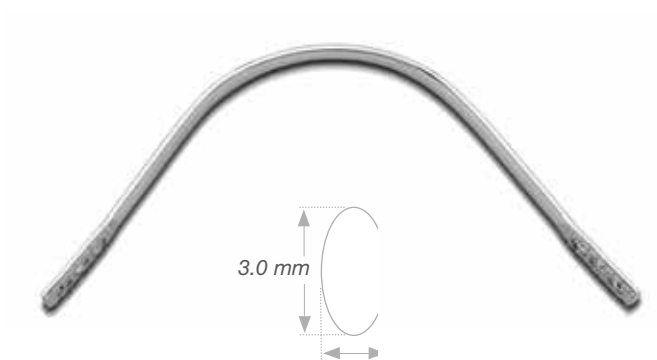



# Orthodontics

Our products are still unsurpassed.

**Quality is not a question of size.** End of the 1950ies, our first orthodontic product was the SCHEU-Anchor – a retention element, still unsurpassed in terms of quality, workmanship and spring force.

Today our orthodontic line is supplemented and enhanced by innovative products such as VECTOR® expansion screws and the CA® CLEAR ALIGNER splint therapy.

Clasps and wires .....	24	Acrylics technique.....	37
CARAT® Wire bending pliers .....	29	Set-up technique .....	41
VECTOR® screws .....	31	Hinges.....	43
Accessories for VECTOR® screws.....	36	Accessories .....	45

# Clasps and wires

Learn more:



## SCHEU-Anchor

Unique retention and spring force! SCHEU-Anchors consist of stainless steel alloys (material DIN no. 1.4301) with excellent resistance to corrosion and oral conditions.

// Ø 0.6 mm	<b>2048.1</b> 10 pieces	<b>2048.2</b> 100 pieces	
// Ø 0.7 mm	<b>2049.1</b> 10 pieces	<b>2049.2</b> 100 pieces	<b>2049.3</b> 1000 pieces
// Ø 0.8 mm	<b>2050.1</b> 10 pieces	<b>2050.2</b> 100 pieces	<b>2050.3</b> 1000 pieces
// Ø 0.9 mm	<b>2051.1</b> 10 pieces	<b>2051.2</b> 100 pieces	<b>2051.3</b> 1000 pieces
// Ø 1.0 mm	<b>2052.1</b> 10 pieces	<b>2052.2</b> 100 pieces	
// Ø 1.2 mm	<b>2053.1</b> 10 pieces	<b>2053.2</b> 100 pieces	

CE 0044

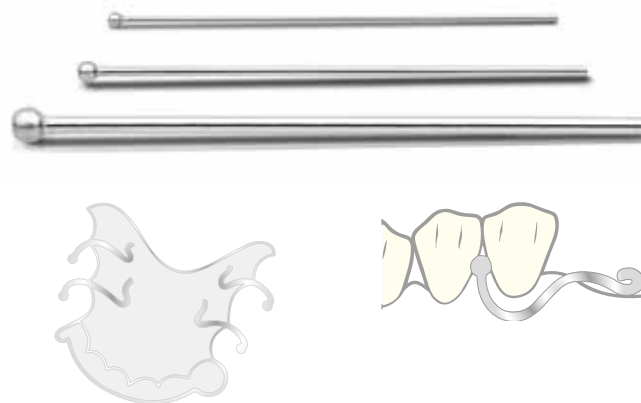

## Adams Clasp

Modified form for optimised retention and easy adjustment. Made of the nickel-free MENZANIUM® alloy – nickel trace elements of 0 to 0.2% are procedurally possible.

// Ø 0.7 mm, width 6 mm	<b>2104.1</b> 10 pieces	<b>2104.2</b> 100 pieces
// Ø 0.7 mm, width 7 mm	<b>2105.1</b> 10 pieces	<b>2105.2</b> 100 pieces
// Ø 0.7 mm, width 8 mm	<b>2106.1</b> 10 pieces	<b>2106.2</b> 100 pieces
// Ø 0.7 mm, width 9 mm	<b>2107.1</b> 10 pieces	<b>2107.2</b> 100 pieces
// Ø 0.7 mm, width 10 mm	<b>2108.1</b> 10 pieces	<b>2108.2</b> 100 pieces
// Ø 0.7 mm, width 11 mm	<b>2109.1</b> 10 pieces	<b>2109.2</b> 100 pieces

CE 0044

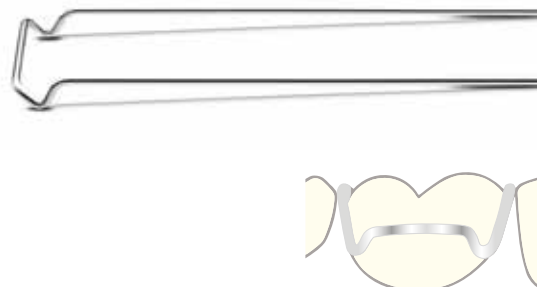

## Triangle Clasp

Made of the nickel-free alloy MENZANIUM®, with high-gloss polished surface. Excellent elasticity and breaking strength. Nickel trace elements from 0 to 0.2% are procedurally possible.

// Ø 0.7 mm	<b>2288.1</b> 100 pieces	<b>2288.2</b> 1000 pieces
// Ø 0.8 mm	<b>2322.1</b> 100 pieces	<b>2322.2</b> 1000 pieces

CE 0044

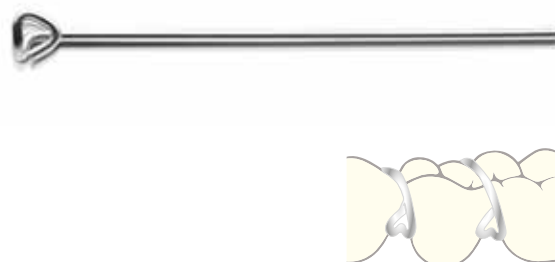



## Arrow Clasp

Made of the nickel-free alloy MENZANIUM®, with high-gloss polished surface. Excellent elasticity and breaking strength. Nickel trace elements from 0 to 0.2% are procedurally possible.

// Ø 0.7 mm

**2055.2**  
100 pieces

// Ø 0.8 mm

**2056.2**  
100 pieces

CE 0044

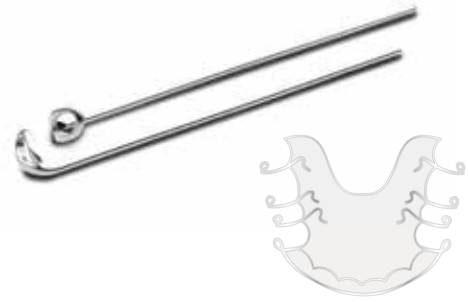

## Coffin spring

Made of the nickel-free MENZANIUM® alloy – nickel trace elements of 0 to 0.2% are procedurally possible.

// Ø 1.2 mm, length 11 mm

**2419.1**  
10 pieces

**2419.2**  
100 pieces

CE

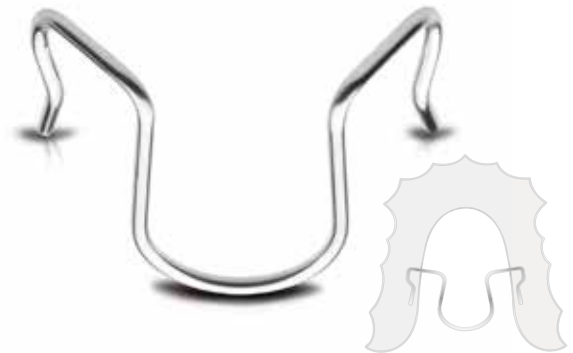

## Frontal guiding bars acc. to Hinz

For treatment of Angle Class II cases (lower jaw retrusion/distal occlusion) in growing patients using protrusive double plates. When using an expansion screw, simultaneous bilateral expansion of the upper jaw is also possible. Made of the nickel-free alloy MENZANIUM® – nickel trace elements from 0 to 0.2 % are procedurally possible.

// Ø 1.2 mm, length 14 mm  
incl. positioning aid

**2329.1**  
5 pairs

// Ø 1.2 mm, length 18 mm  
incl. positioning aid

**2330.1**  
5 pairs

CE



## U-Bar acc. to Karwetzky

Functional orthodontic appliance enabling the lower jaw to move in the required position depending on the type (1 - 3). U-bars acc. to Karwetzky consist of stainless steel alloys with excellent resistance to corrosion and oral conditions.

// U-Bar acc. to Karwetzky  
wire diameter: 1.2 mm

**2118.1**  
5 pairs

**2118.2**  
50 pairs

CE



# MENZANIUM®

MENZANIUM® is a nickel-free stainless steel alloy, fabricated in a patented high pressure melting process replacing allergenic components of nickel by manganese and nitrogen. Compared to conventional stainless steel wires, corrosion resistance and breaking strength are increased. Wire is available in two versions hard (1400-1600 N/mm<sup>2</sup>) and spring hard (1800-2000 N/mm<sup>2</sup>). Processing by joining techniques such as laser-welding and welding. Measurements, tolerances and quality in accordance with DIN EN ISO 15841.

Learn more:



## MENZANIUM® Coil wire

Diamond drawn and high gloss polished, available as laboratory coil (10-50 m wire length) or clinical coil (500 g / 58-330 m wire length).

// Ø 0.7 mm / .028 inch, hard	<b>8453.1</b> 30 m	<b>8453.2</b> 500 g
// Ø 0.8 mm / .032 inch, hard	<b>8454.1</b> 20 m	<b>8454.2</b> 500 g
// Ø 0.9 mm / .036 inch, hard	<b>8455.1</b> 10 m	<b>8455.2</b> 500 g
// Ø 1.0 mm / .040 inch, hard	<b>8456.1</b> 10 m	
// Ø 0.5 mm / .020 inch, spring hard	<b>8459.1</b> 50 m	
// Ø 0.6 mm / .024 inch, spring hard	<b>8460.1</b> 40 m	<b>8460.2</b> 500 g
// Ø 0.7 mm / .028 inch, spring hard	<b>8461.1</b> 30 m	<b>8461.2</b> 500 g
// Ø 0.8 mm / .032 inch, spring hard	<b>8462.1</b> 20 m	<b>8462.2</b> 500 g
// Ø 0.9 mm / .036 inch, spring hard	<b>8463.1</b> 10 m	<b>8463.2</b> 500 g
// Ø 1.0 mm / .040 inch, spring hard	<b>8464.1</b> 10 m	<b>8464.2</b> 500 g
// Ø 1.2 mm / .048 inch, spring hard	<b>8466.1</b> 10 m	<b>8466.2</b> 500 g

Nickel trace elements of 0-0.2% are procedurally possible.

CE 0044



## MENZANIUM® Wire rods

Crosscut and aligned, in packages of 500 g.

// Ø 0.7 mm / .028 inch, length 75 mm, hard	<b>8480.1</b> 500 g
// Ø 0.7 mm / .028 inch, length 150 mm, hard	<b>8482.1</b> 500 g
// Ø 0.6 mm / .024 inch, length 75 mm, spring hard	<b>8478.1</b> 500 g
// Ø 0.7 mm / .028 inch, length 75 mm, spring hard	<b>8467.1</b> 500 g
// Ø 0.7 mm / .028 inch, length 150 mm, spring hard	<b>8468.1</b> 500 g
// Ø 0.8 mm / .032 inch, length 150 mm, spring hard	<b>8469.1</b> 500 g
// Ø 0.8 mm / .032 inch, length 200 mm, spring hard	<b>8470.1</b> 500 g
// Ø 0.9 mm / .036 inch, length 150 mm, spring hard	<b>8471.1</b> 500 g
// Ø 0.9 mm / .036 inch, length 200 mm, spring hard	<b>8472.1</b> 500 g
// Ø 1.0 mm / .040 inch, length 200 mm, spring hard	<b>8473.1</b> 500 g

Nickel trace elements of 0 - 0.2% are procedurally possible.

CE 0044

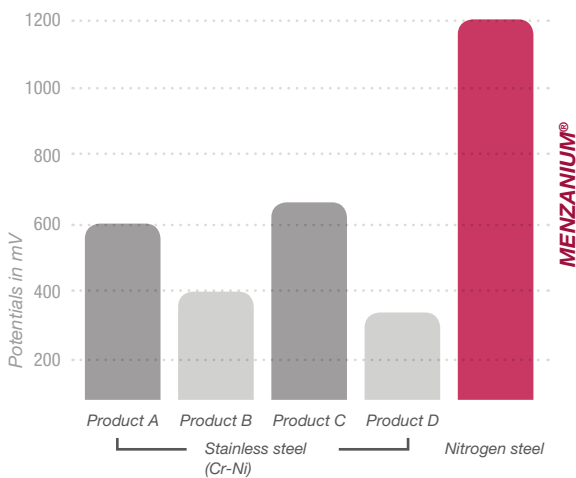

### Breakdown potential for wires from the group of iron alloys

Electrochemical study of corrosion properties of orthodontic auxiliaries in artificial saliva (reference electrode Ag / AgCl, feed rate: 1 m V/sec).

M. Neuhöfer: "Experimental Dentistry", dissertation 1993, University of Freiburg, head: Prof. Dr. H. F. Kappert

# CHROMIUM

Wire made of chrome nickel steel (DIN material no. 1.4310), available in two versions hard (1400-1600 N/mm<sup>2</sup>) and spring hard (1800-2000 N/mm<sup>2</sup>). Processing by joining techniques such as laser-welding and welding. Measurements, tolerances and quality in accordance with DIN EN ISO 15841.

Learn more:



## CHROMIUM Coil wire

Diamond drawn and high gloss polished, available as laboratory coil (10-50 m wire length) or clinical coil (500 g / 26-324 m wire length).

// Ø 0.5 mm / .020 inch, hard	<b>8323.1</b>	
	50 m	
// Ø 0.6 mm / .024 inch, hard	<b>8324.1</b>	
	40 m	
// Ø 0.7 mm / .028 inch, hard	<b>8325.1</b>	<b>8325.2</b>
	30 m	500 g
// Ø 0.8 mm / .032 inch, hard	<b>8326.1</b>	<b>8326.2</b>
	20 m	500 g
// Ø 0.9 mm / .036 inch, hard	<b>8327.1</b>	<b>8327.2</b>
	10 m	500 g
// Ø 1.0 mm / .040 inch, hard	<b>8328.1</b>	<b>8328.2</b>
	10 m	500 g
// Ø 1.1 mm / .044 inch, hard	<b>8329.1</b>	
	10 m	
// Ø 1.2 mm / .048 inch, hard	<b>8338.1</b>	
	10 m	
// Ø 1.5 mm / .059 inch, hard		<b>8382.2</b>
		500 g
// Ø 0.5 mm / .020 inch, spring hard	<b>8330.1</b>	
	50 m	
// Ø 0.6 mm / .024 inch, spring hard	<b>8331.1</b>	<b>8331.2</b>
	40 m	500 g
// Ø 0.7 mm / .028 inch, spring hard	<b>8332.1</b>	<b>8332.2</b>
	30 m	500 g
// Ø 0.8 mm / .032 inch, spring hard	<b>8333.1</b>	<b>8333.2</b>
	20 m	500 g
// Ø 0.9 mm / .036 inch, spring hard	<b>8334.1</b>	<b>8334.2</b>
	10 m	500 g
// Ø 1.0 mm / .040 inch, spring hard	<b>8335.1</b>	<b>8335.2</b>
	10 m	500 g
// Ø 1.1 mm / .044 inch, spring hard	<b>8336.1</b>	<b>8336.2</b>
	10 m	500 g
// Ø 1.2 mm / .048 inch, spring hard	<b>8339.1</b>	<b>8339.2</b>
	10 m	500 g
// CHROMIUM coil wire, Ø 1.5 mm / .059 inch, spring hard	<b>8383.2</b>	
		500 g

CE 0044



## CHROMIUM Wire rods

Crosscut and aligned, in packages of 500 g.

// Ø 0.7 mm / .028 inch, length 100 mm, hard	<b>8293.1</b>
	500 g
// Ø 0.7 mm / .028 inch, length 150 mm, hard	<b>8294.1</b>
	500 g
// Ø 0.8 mm / .032 inch, length 150 mm, hard	<b>8297.1</b>
	500 g
// Ø 0.7 mm / .028 inch, length 75 mm, spring hard	<b>8306.1</b>
	500 g
// Ø 0.7 mm / .028 inch, length 100 mm, spring hard	<b>8307.1</b>
	500 g
// Ø 0.7 mm / .028 inch, length 150 mm, spring hard	<b>8308.1</b>
	500 g
// Ø 0.8 mm / .032 inch, length 150 mm, spring hard	<b>8311.1</b>
	500 g
// Ø 0.8 mm / .032 inch, length 200 mm, spring hard	<b>8312.1</b>
	500 g
// Ø 0.9 mm / .036 inch, length 150 mm, spring hard	<b>8313.1</b>
	500 g
// Ø 0.9 mm / .036 inch, length 200 mm, spring hard	<b>8314.1</b>
	500 g

CE 0044

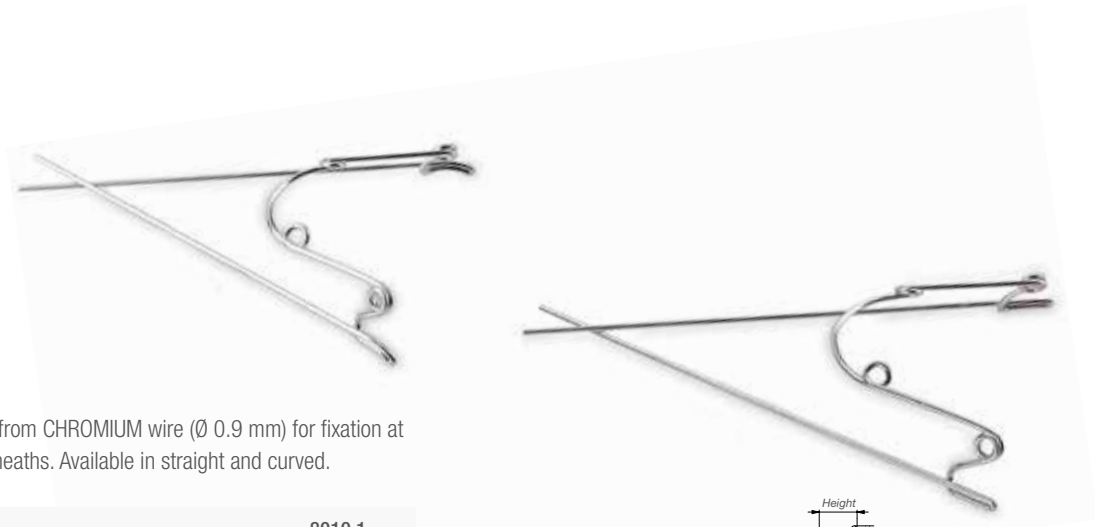

## Quad Helix

Ready-made expansion arch from CHROMIUM wire (Ø 0.9 mm) for fixation at the upper molars in palatal sheaths. Available in straight and curved.

// size 1, straight sheath	<b>8010.1</b> 5 pieces
// size 1, curved sheath	<b>8011.1</b> 5 pieces
// size 2, straight sheath	<b>8020.1</b> 5 pieces
// size 2, curved sheath	<b>8021.1</b> 5 pieces
// size 3, straight sheath	<b>8030.1</b> 5 pieces
// size 3, curved sheath	<b>8031.1</b> 5 pieces

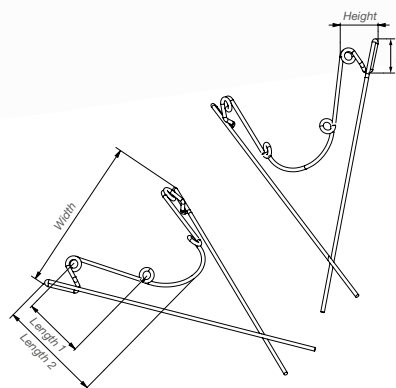

CE 0044

	straight			curved		
	8010 Size 1	8020 Size 2	8030 Size 3	8011 Size 1	8021 Size 2	8031 Size 3
Length 1	13	16	17.5	13	16	17.5
Length 2	25	27	29	25	27	29
Width	36	39	45	36	39	45
Height	9	9	9	10	10	10
S	5.5 + 1					

S = dimension sheath

## Lingual/palatal sheath

Stainless steel sheaths for soldering or laser-welding on molar bands. Available in straight and curved.

// straight	<b>8080.1</b> 5 pieces
// curved	<b>8081.1</b> 5 pieces

CE 0044



## CARAT® Wire bending pliers

Pliers made of high quality stainless steel alloy with exactly machined tool tips and precisely guided sheaths. Ergonomic design with rounded edges for fatigue-free working.

Learn more:



### CARAT® Aderer pliers large

Aderer wire bending pliers, three prong with reinforced plier tips, for wires up to 0.9 mm diameter.

/// CARAT® Aderer pliers large

2044.1  
1 piece



### CARAT® Aderer pliers medium

Aderer wire bending pliers, three prong with reinforced plier tips, for wires up to 0.7 mm diameter.

/// CARAT® Aderer pliers medium

2046.1  
1 piece



### CARAT® Angle pliers (HM)

Carbide wire bending pliers with a square and a round tip (tungsten carbide), for wires up to 0.7 mm diameter.

/// CARAT® Angle pliers (HM)

2043.1  
1 piece

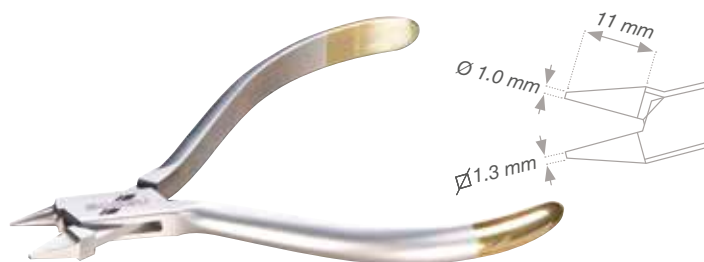

### CARAT® Flat pliers

Flat needle-nose pliers according to Marburg model with delicate chequered guiding tips.

/// CARAT® Flat pliers

2041.1  
1 piece

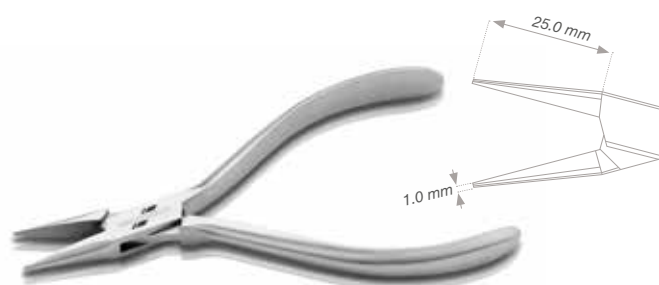

## CARAT® Crampon pliers

Pin and wire cutting and bending pliers with chequered and crenate tips, suitable for hard ( $\varnothing$  up to 1.2 mm) and soft wires ( $\varnothing$  up to 1.5 mm).

/// CARAT® Crampon pliers

2040.1  
1 piece



## CARAT® Young pliers

Loop and arch bending pliers with multiple crenate tips for labial arches and hard wire ( $\varnothing$  bis 0.9 mm).

/// CARAT® Young pliers

2042.1  
1 piece

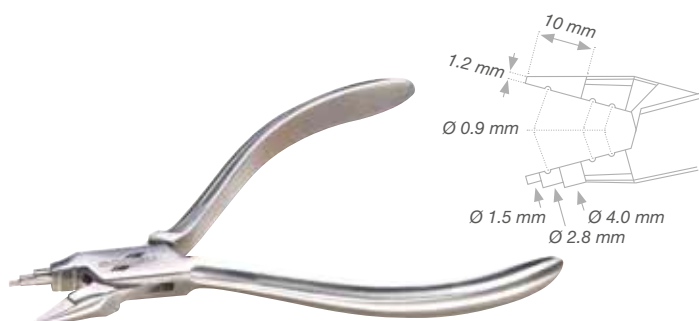

## Ortho arch bender

Bending aid from high strength aluminium alloy with 11 different radii for forming round wire ( $\varnothing$  0.5 - 1.5 mm) and square wire (up to 0.8 mm / 031"). High-gloss polished, with laser inscription.

/// Ortho arch bender

8450.1  
1 piece



# VECTOR® screws

Standard expansion screws, traction screws and special screws with stable construction, skeletal structure and directional arrow, e.g. in miniaturized design, as multi-sectional Bertoni screw or palatal expansion screw. Please refer to the table in the appendix for indications on expansion.



## VECTOR® 30

Special miniaturised sector screw with bright yellow directional arrow for single tooth movements. To ensure safe anchorage, retention wires (CHROMIUM Ø 0.8 mm, not included) can be individually inserted and adjusted. Can also be used in the CA® CLEAR ALIGNER technology for oblique-lateral segment expansion acc. to Dr. Pablo Echarri in conjunction with a CHROMIUM wire (0.8 mm) and two VECTOR® 30 screws.

Comes with key for expansion screws.

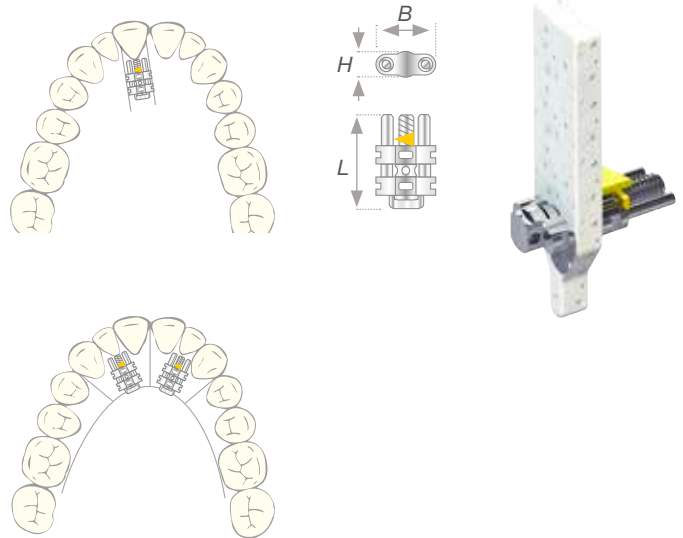

/// special sector screw  
4.80 x 2.60 x 9.50 mm  
Expansion 3.0 mm

**2484.1** 2484.2  
2 pieces 10 pieces

CE

## VECTOR® 40 acc. to Prof. Hinz

Special miniaturised screw with black directional arrow for fabrication of CA® splints, allowing expansions in the lower jaw (up to 3 mm). The retention arms allow safe anchorage using cold curing resin.

/// special screw micro  
3.60 x 2.50 x 19.00 mm  
Expansion 3.0 mm

**2486.1** 2486.2  
10 pieces 50 pieces

CE

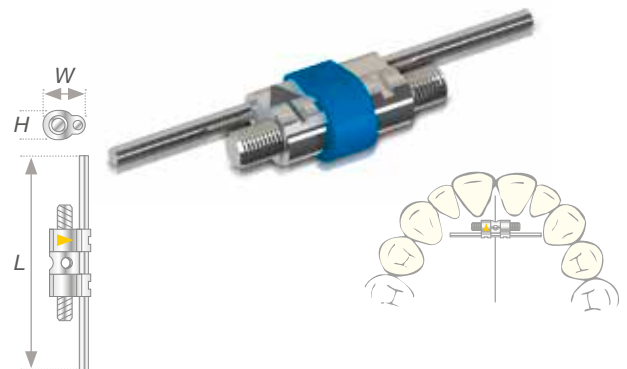

### New: 45 M

## VECTOR® 45 / 45 M acc. to Prof. Hinz

Miniaturised expansion screw with bright yellow directional arrow for fabrication of CA® splints, allowing activation and fan-type expansion (up to 3 or 6 mm). Comes with elongated guiding pins for secure anchorage with cold cure resin and torsion-free expansion. In particular for use in the upper jaw.

/// VECTOR® 45 acc. to Prof. Hinz  
4.70 x 2.50 x 19.00 mm  
Expansion 3.0 mm

**2487.1**  
10 pieces

/// VECTOR® 45 M acc. to Prof. Hinz  
4.70 x 2.50 x 19.00 mm  
expansion 6.0 mm

**2488.1**  
10 pieces

CE

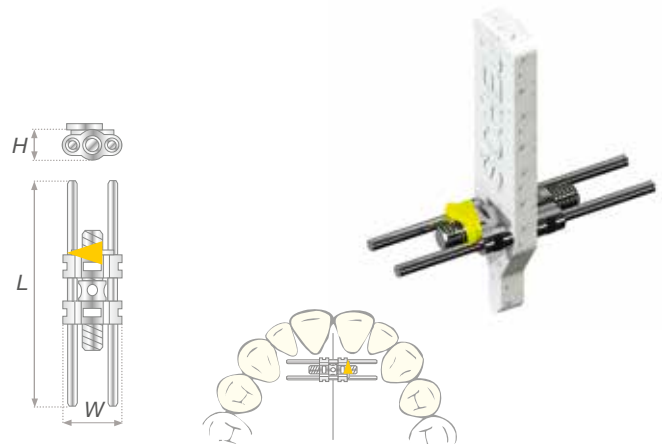

## VECTOR® 50

Skeletal miniaturised expansion screw with bright yellow directional arrow for transversal expansion in the lower jaw, also for narrow upper jaws.

<b>//</b> standard expansion screw micro	<b>2489.1</b>	<b>2489.2</b>
4.70 x 2.50 x 10.00 mm	10 pieces	50 pieces
Expansion 3.0 mm		

CE

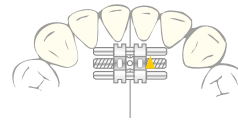
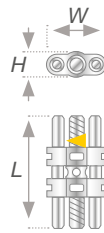

## VECTOR® 80

Skeletal expansion screw with bright yellow directional arrow for transversal expansion of the lower jaw. Additional bore hole ensures excellent retention in acrylics.

<b>//</b> standard expansion screw medium	<b>2490.1</b>	<b>2490.2</b>
7.00 x 3.10 x 14.30 mm	10 pieces	50 pieces
expansion 7.5 mm		

CE

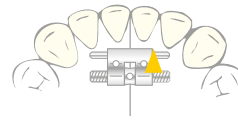
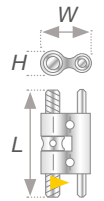

## VECTOR® 90 / 100

Skeletal expansion screw with bright yellow directional arrow for transversal expansion of the lower jaw. For treatment of Angle Class II cases we recommend using VECTOR® 100 in combination with VECTOR® 900.

<b>//</b> VECTOR® 90, standard expansion screw mini	<b>2491.1</b>	<b>2491.2</b>
6.20 x 2.80 x 10.00 mm	10 pieces	50 pieces
Expansion 4.0 mm		
<b>//</b> VECTOR® 100, standard expansion screw mini	<b>2492.1</b>	<b>2492.2</b>
6.20 x 2.80 x 12.00 mm	10 pieces	50 pieces
Expansion 5.0 mm		

CE

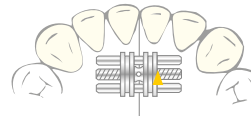
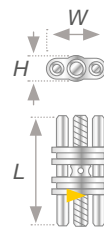

## VECTOR® 140 / 160

Skeletal expansion screw with bright yellow directional arrow for transversal and sagittal expansion in the upper and lower jaw.

<b>//</b> VECTOR® 140, standard expansion screw medium	<b>2494.1</b>	<b>2494.2</b>
7.50 x 3.50 x 12.00 mm	10 pieces	50 pieces
Expansion 5.0 mm		
<b>//</b> VECTOR® 160, standard expansion screw medium	<b>2496.1</b>	<b>2496.2</b>
7.50 x 3.50 x 14.30 mm	10 pieces	50 pieces
Expansion 6.0 mm		

CE

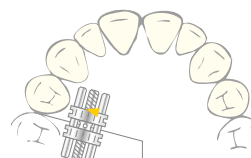
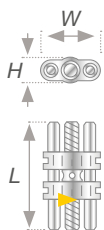



## VECTOR® 190 / 200

Stable, skeletal expansion screw with bright yellow directional arrow for transversal expansion of the upper jaw and bimaxillary appliances. Additional bore hole ensures excellent retention in acrylics.

<b>//</b> VECTOR® 190, standard expansion screw medium 10.00 x 3.10 x 10.00 mm Expansion 5.0 mm	<b>2497.1</b> 10 pieces	<b>2497.2</b> 50 pieces
---	----------------------------	----------------------------

<b>//</b> VECTOR® 200, standard expansion screw maxi 10.00 x 3.10 x 14.30 mm Expansion 7.5 mm	<b>2498.1</b> 10 pieces	<b>2498.2</b> 50 pieces
---	----------------------------	----------------------------

CE

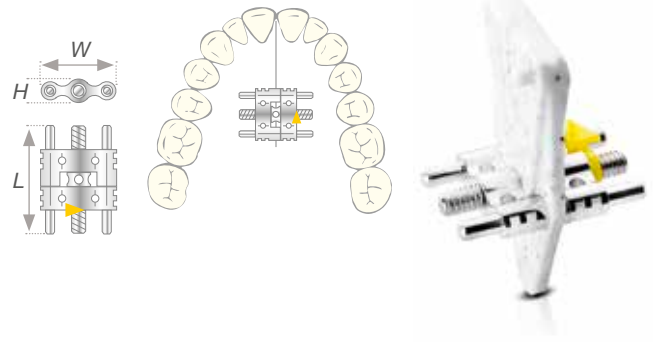

## VECTOR® 350

Skeletal miniaturised sector expansion screw with bright yellow directional arrow for single tooth and segment movement in the upper and lower jaw.

<b>//</b> sector expansion screw micro 4.70 x 2.50 x 10.50 mm Expansion 4.0 mm	<b>2509.1</b> 10 pieces	<b>2509.2</b> 50 pieces
--	----------------------------	----------------------------

CE

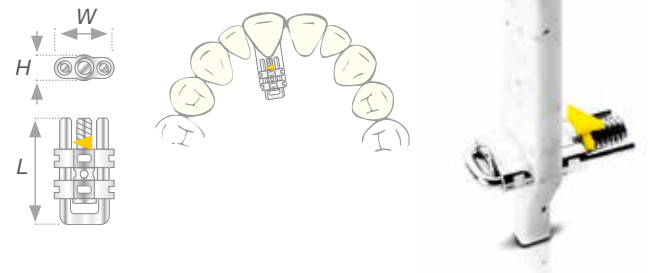

## VECTOR® 400

Delicate skeletal sector expansion screw with bright yellow directional arrow. Can also be used for single tooth movements.

<b>//</b> sector expansion screw mini 6.20 x 2.80 x 11.00 mm Expansion 3.0 mm	<b>2510.1</b> 10 pieces	<b>2510.2</b> 50 pieces
---	----------------------------	----------------------------

CE

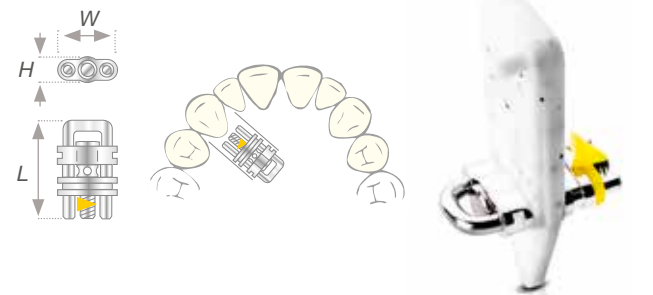

## VECTOR® 420

Delicate skeletal sector expansion screw with bright yellow directional arrow. Can be used for distalisation and for single tooth movements.

<b>//</b> sector expansion screw mini 6.20 x 2.80 x 13.00 mm Expansion 5.0 mm	<b>2512.1</b> 10 pieces	<b>2512.2</b> 50 pieces
---	----------------------------	----------------------------

CE

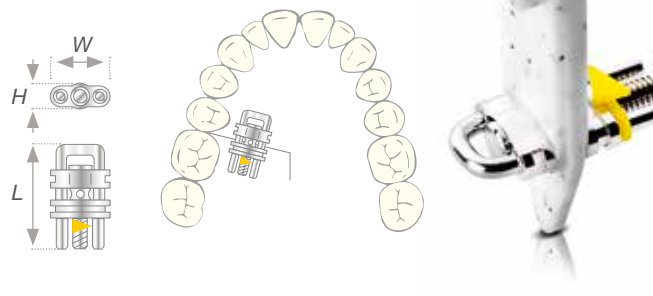

## VECTOR® 440

Delicate skeletal sector expansion screw with bright yellow directional arrow, for distalisation.

<b>//</b> sector expansion screw mini 6.20 x 2.80 x 13.50 mm Expansion 5.0 mm	<b>2514.1</b> 10 pieces
---	----------------------------

CE

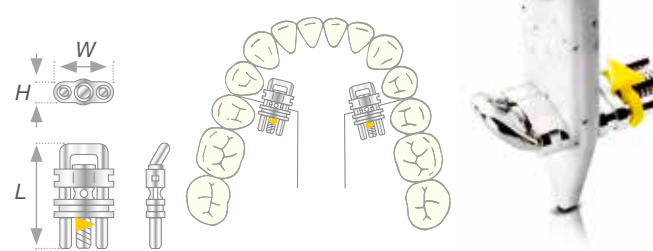

## VECTOR® 440R

Delicate skeletal sector expansion screw with bright yellow directional arrow for single tooth or segment movement.

/// sector expansion screw mini  
6.20 x 2.80 x 13.50 mm  
Expansion 5.0 mm

**2513.1**  
10 pieces

CE

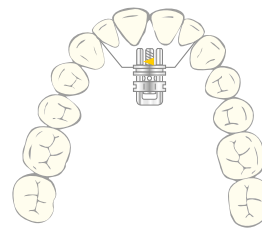
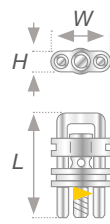

## VECTOR® 460

Skeletal sector expansion screw in stronger version with bright yellow directional arrow.

/// sector expansion screw medium  
7.50 x 3.50 x 13.00 mm  
Expansion 5.0 mm

**2516.1**  
10 pieces

CE

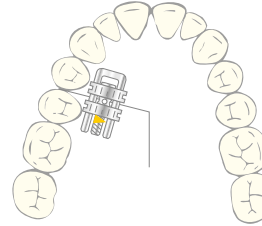
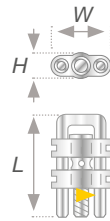

## VECTOR® 500 / 520

Traction screw for space closure with black directional arrow on the housing.

/// VECTOR® 500, traction screw  
6.20 x 2.80 x 13.50 mm

**2520.1**  
10 pieces

/// VECTOR® 520, traction screw  
6.20 x 2.80 x 18.00 mm

**2522.1**  
10 pieces

CE

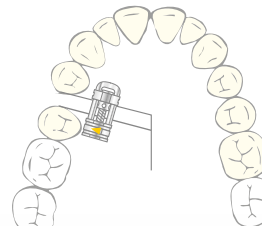
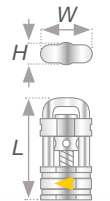

## VECTOR® 600 / 620

Special screw for rapid palatal expansion. The anatomically bent retention arms are soldered or welded onto molar bands. The specifically designed housing profile fits perfectly the palatal vault. The integrated polyamide bush prevents accidental resetting of the screw. Laser-welded indication for rotation and expansion on the housing. Comes with security expansion key.

Not suitable for surgically assisted rapid palatal expansion. Protect screw body from excessive heat to avoid damaging the integrated polyamide bushing and jamming of the screw.

/// VECTOR® 600, rapid palatal expansion screw  
10.40 x 4.00 x 13.00 mm  
Expansion 9.0 mm

**2524.1**  
1 piece

**2524.2**  
10 pieces

/// VECTOR® 620, rapid palatal expansion screw  
10.40 x 4.00 x 15.00 mm  
Expansion 11.0 mm

**2526.1**  
1 piece

**2526.2**  
10 pieces

CE 0044

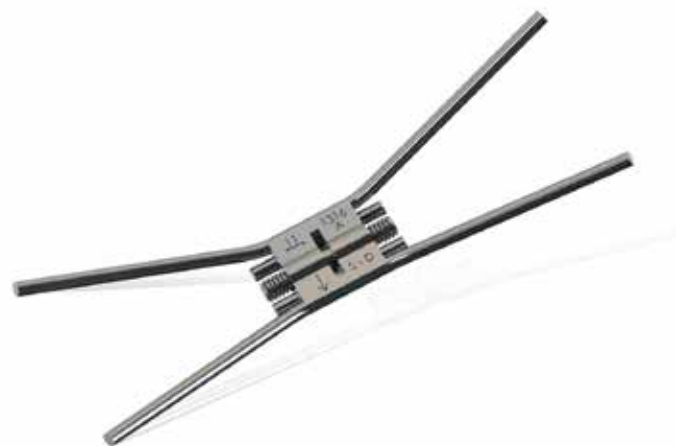
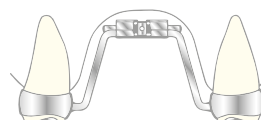
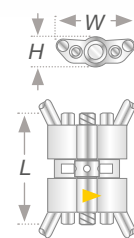

## VECTOR® 720 acc. to Bertoni

Special Bertoni screw for insertion in multi-sector plates, enabling separate protrusion and symmetric transversal expansion by two independently operating spindles.

**// VECTOR® 720 acc. to Bertoni**  
 17.00 x 2.80 x 15.50 mm  
 Expansion 5.5 mm, Transversal expansion 7,00 mm

**2530.1**  
 2 pieces

CE

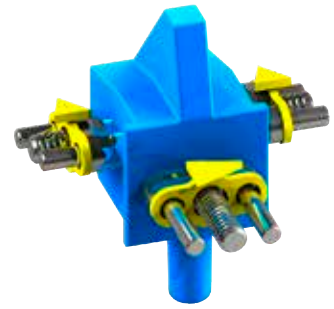
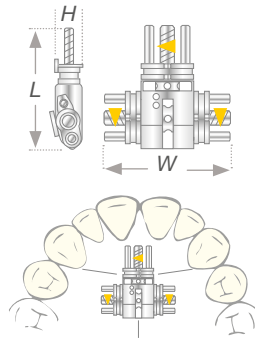

## VECTOR® 730 acc. to Bertoni

Special Bertoni screw for insertion in multi-sector plates, enabling separate protrusion and symmetric or asymmetric transversal expansion by three independently operating spindles.

**// VECTOR® 730 acc. to Bertoni**  
 17.00 x 2.80 x 15.50 mm  
 Expansion 5.5 mm, Transversal expansion 2 x 3,50 mm

**2532.1**  
 2 pieces

CE

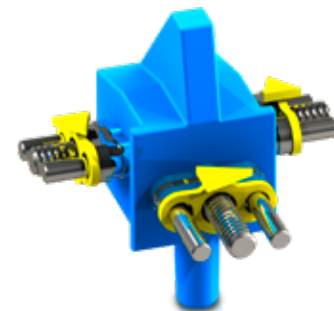
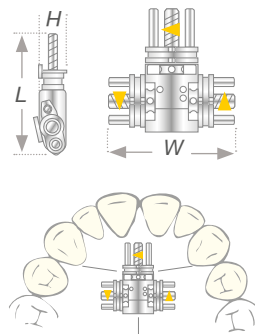

## VECTOR® 740 acc. to Bertoni

Modified angled and delicate Bertoni screw for insertion in multi-sector plates, enabling separate protrusion and symmetric transversal expansion by two independently operating spindles.

**// VECTOR® 740 acc. to Bertoni**  
 15.00 x 5.00 x 14.50 mm  
 Expansion 2.5 mm, Transversal expansion 5,00 mm

**2540.1**  
 2 pieces

CE

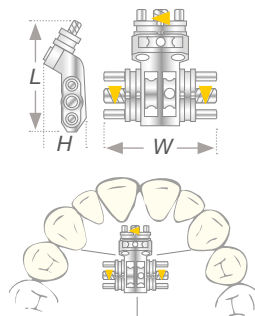

## VECTOR® 750 acc. to Bertoni

Modified angled and delicate Bertoni screw for insertion in multi-sector plates, enabling separate protrusion and symmetric or asymmetric transversal expansion by three independently operating spindles, for bilateral expansion.

**// VECTOR® 750 acc. to Bertoni**  
 15.00 x 5.00 x 14.50 mm  
 Expansion 2.5 mm, Transversal expansion 2 x 2,50 mm

**2542.1**  
 2 pieces

CE

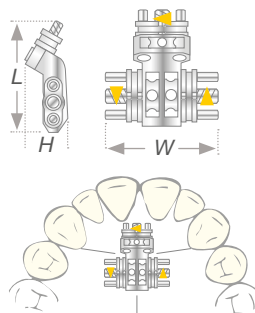

## VECTOR® 800 / 820

Special miniaturised screw for distraction of the lower jaw using stable retention arms of 60 mm length. With laser marking on housing.

Not suitable for surgically assisted rapid palatal expansion.

**// VECTOR® 800** **2533.1**  
1 piece  
6.70 x 3.10 x 13.00 mm  
Expansion 9.0 mm

**// VECTOR® 820** **2534.1**  
1 piece  
6.70 x 3.10 x 15.00 mm  
Expansion 11.0 mm

CE 0044

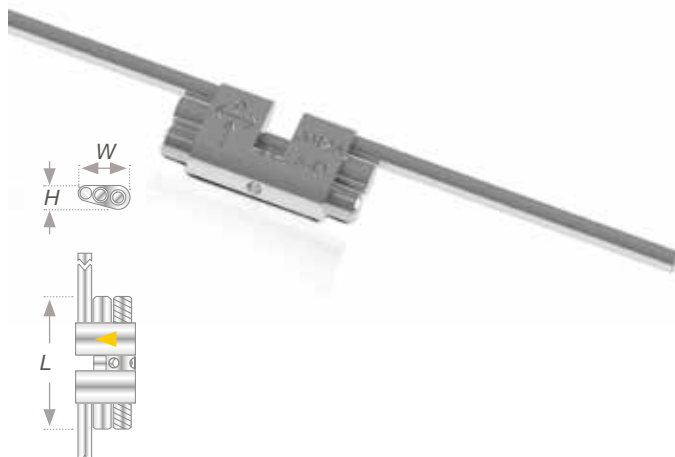

## VECTOR® 900

For treatment of Angle Class II cases (lower jaw retrusion/distal occlusion) in growing patients using protrusive double plates. Simultaneous bilateral expansion of upper jaw is also possible. Compact design with integrated expansion screw, comes with key for expansion. For lower jaw we recommend the combined use with VECTOR® 100 screw as well as the angle tester acc. to Adamik (REF2332) for control of correct positioning.

**// VECTOR® 900** **2537.1**  
1 piece **2537.2**  
10 pieces  
14.00 x 20.00 x 13.00 mm  
expansion 5.0 mm

CE

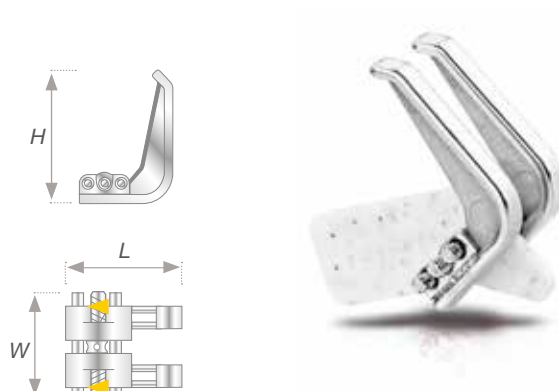

## Accessories for VECTOR® screws

### Key for expansion screws

For precise adjustment of VECTOR® expansion screws.

**// Key for expansion screws** **2101.2**  
100 pieces

CE

### Security key for expansion screws

For HF5, HF9 and HF15 telescopes (IST® devices) and all kinds of palatal expansion screws.

**// Security key for expansion screws** **2100.1**  
10 pieces

CE



# Acrylics technique

Learn more:



## STEADY-RESIN S

Cold-curing resin for the "salt and pepper" technique. This polymer meets the requirements of the "salt and pepper" technique, such as high stability and optimum wettability.

// polymer

8134.1  
1 kg

CE 0044



## STEADY-RESIN M

Cold-curing resin for the "premix" technique. Characterised by a wide processing range and excellent modelling properties.

// polymer

8135.1  
1 kg

CE 0044



## STEADY-RESIN VARIO

Cold-curing resin for orthodontics with prolonged processing time, can be used both for "salt and pepper" and for the modelling techniques.

// polymer

8140.1  
1 kg

CE 0044



## STEADY-RESIN S+M

Universal monomer, can be processed with all STEADY-RESIN polymer versions. The clear monomer can be mixed with STEADY-RESIN coloured monomers.

// monomer, clear

8136.1  
500 ml

// monomer, pink

8137.1  
500 ml

CE 0044



## STEADY-RESIN Coloured monomer

Ready-to-use coloured STEADY-RESIN monomers for use with STEADY-RESIN S, M and VARIO as well as DURASPLINT® polymer.

// blue	8351.1 100 ml	8351.2 0.25 l
// yellow	8352.1 100 ml	8352.2 0.25 l
// red	8353.1 100 ml	8353.2 0.25 l
// black	8354.1 100 ml	8354.2 0.25 l
// green	8355.1 100 ml	8355.2 0.25 l
// violet	8356.1 100 ml	8356.2 0.25 l

CE 0044



## STEADY-RESIN Neon monomer

Ready-to-use coloured neon monomers for use with STEADY-RESIN S, M and VARIO as well as DURASPLINT® polymer. For streak-free and translucent results.

// neon pink	8350.1 100 ml	8350.2 0.25 l
// neon red	8357.1 100 ml	8357.2 0.25 l
// neon yellow	8358.1 100 ml	8358.2 0.25 l
// neon green	8359.1 100 ml	8359.2 0.25 l
// neon blue	8360.1 100 ml	8360.2 0.25 l
// neon orange	8361.1 100 ml	8361.2 0.25 l

CE 0044

## STEADY-RESIN Polymer

Pre-mixed polymer in two colours. Innovative pigments provide contrasting effects.

// black	8130.1 200 g
// white	8131.1 200 g

CE 0044



## Mica

For individual use with STEADY-RESIN and DURASPLINT® polymer. Blends rainbow, rainbow green and rainbow violet are completely metal-free and ensure iridescent effects in delicate pastel shades.

// silver	8144.1 50 g
// gold	8145.1 50 g
// blue	8146.1 50 g
// red	8147.1 50 g
// green	8148.1 50 g
// rainbow	8150.1 50 g
// rainbow green	8151.1 50 g
// rainbow violet	8152.1 50 g

CE



## RESIMIX®

Original mixing cups of clear silicone, stable by strong suction base. Very practical pouring spout for medium and large version.

// 5 ml, 3 pieces	7243.1 1 set
// 30 ml, 2 pieces	7284.1 1 set
// 70 ml, 1 piece	7244.1 1 piece



**New**

## IMPRIMO® Model Separator

Water-based, blue-transparent gel for the insulation of 3D-printed models in the fabrication of removable orthodontic appliances. By forming an even film on the model, an optimal insulating effect is ensured between IMPRIMO® LC printer resins and STEADY-RESIN self-curing resins.

Apply thinly with a brush and allow to dry thoroughly. Not suitable for 3D models generated by a filament printer.

Available as 100 ml pump bottle incl. brush or as refill in 500 ml refill bottle. STL data set for 3D printing of rack for pump bottle and brush available as download.

Contains no volatile organic solvents. Product is not hazardous in terms of the transport guidelines.



// IMPRIMO® Model Separator	<b>6551.1</b> 100 ml	<b>6551.2</b> 500 ml
-----------------------------	-------------------------	-------------------------



## 3D Model insulation

Insulating agent for 3D-printed models when processing self-curing resins, such as STEADY-RESIN S and IMPRIMO® LC printer resins. Application with the enclosed brush results in an optimal insulating effect, which is achieved by forming a thin layer of micro wax beads on the model surface. Not suitable for 3D models from a filament printer.

For extraoral use only.

Product is not hazardous in terms of transport guidelines.

// 3D Model insulation	<b>6510.1</b> 65 ml
------------------------	------------------------

## Orthodontic insulating agent

Alginate insulation for plaster models. Single apply provides optimum insulation.

// Orthodontic insulating agent	<b>8364.1</b> 500 ml
---------------------------------	-------------------------



## Spray bottle / spray nozzles

Spray bottle with dosing tip and cap is suitable for both monomer and polymer. Perfect dosing by piercing the tip with a needle.

Optional spray nozzles available for easier dosing of polymer and monomer that can be mounted on the bottle.

// Metal spray nozzles for monomer	<b>8138.1</b> 5 pieces
// Metal spray nozzles for polymer	<b>8139.1</b> 5 pieces
// Spray bottle, 100 ml	<b>8141.1</b> 1 piece



# Set-up technique

Learn more:



## Set-up plaster

White formaldehyde-free plaster offers best conditions for use in general orthodontics and the CA® CLEAR ALIGNER technology.

### Technical data according to DIN EN ISO 6873

Compressive strength after 24 hours 65 MPa

Expansion after 2 hours < 0.09 %

<b>//</b> Set-up plaster	<b>5266.1</b> 2.5 kg	<b>5266.2</b> 5 kg
--------------------------	-------------------------	-----------------------



Orthodontics

## Set-up manual saw

The angled bar allows precise and controlled separation of the individual tooth segments.

Saw blades available in two sizes.

<b>//</b> Set-up manual saw	<b>5372.1</b> 1 piece
<b>//</b> Saw blades W x H x L: 0.15 x 2.0 x 75.0 mm	<b>5373.1</b> 10 pieces
<b>//</b> Saw blades W x H x L: 0.20 x 2.0 x 75.0 mm	<b>5379.1</b> 10 pieces



## BLUE-BLOKKER®

Light-curing, blue-transparent blocking-out and modelling putty with optimum flow properties. For fabrication of space holders for bleaching splints and medical trays as well as for sealing and blocking set-up models. Burns without leaving any residue, can therefore also be used in prosthetics for the fabrication of fixed and removable dentures. Telescopic models are stable and can be withdrawn without tension. Curing in the wavelength range of 380 - 470 nm.

<b>//</b> 4 x 1.5 g incl. 2 cannula Ø 0.6 mm and 8 cannula Ø 0.9 mm	<b>5276.1</b> 1 piece
--	--------------------------



## Set-up wax blocks

Fast-melting wax for transpositions in orthodontics.

// red

**5368.1**  
1 set



## Set-up wax rods

Soft set-up wax with good adhesion properties.

// opaque

**5268.1**  
25 pieces



## Diamond separating disc

Diamond coated on both sides (thickness 0.28 mm) for very precise saw cuts on set-up models and for finishing splints.

// Diamond separating disc  
mounted on mandrel, Ø 22 mm  
maximum rotational speed: 5,000 r/min

**5288.1**  
1 piece



## Set-up trimmer

Special carbide bur for drilling and vertical cuts.

// Set-up trimmer  
10,000 r/min

**5371.1**  
1 piece



# Hinges

Learn more:



## Hinge system acc. to Herbst

For treatment of class II cases, for soldering or welding on cast or ready-made bands. Without limit stop.

// without fastening elements 1 pair of hinges	<b>5478.1</b> 1 pair
// with hexagon socket screws Set: 1 pair of hinges and 4 pairs of fastening elements incl. hexagon socket screws	<b>5479.1</b> 1 pair
// with slotted screws Set: 1 pair of hinges and 4 pairs of fastening elements incl. slotted screws	<b>5480.1</b> 1 pair

CE 0044

Herbst is a registered trade mark of DENTAURUM GmbH & Co. KG, Ispringen.



Orthodontics

## Fastening elements for Herbst appliance

Come with slotted or hexagon socket screws, to be welded or soldered on cast or ready-made bands.

// with hexagon socket screws 4 pairs of fastening elements incl. hexagon socket screws	<b>5455.1</b> 4 pairs
// with slotted screws 4 pairs of fastening elements incl. slotted screws	<b>5456.1</b> 4 pairs

CE 0044

Herbst is a registered trade mark of DENTAURUM GmbH & Co. KG, Ispringen.



## Distance rings

When fabricating Herbst appliances, distance rings can be slid onto connecting rods, enabling progressive re-activation. Inner diameter: 2.0 mm.

// length 1 mm	<b>5481.1</b> 10 pieces
// length 2 mm	<b>5482.1</b> 10 pieces
// length 3 mm	<b>5483.1</b> 10 pieces
// length 4 mm	<b>5484.1</b> 10 pieces
// length 5 mm	<b>5485.1</b> 10 pieces

CE 0044

Herbst is a registered trade mark of DENTAURUM GmbH & Co. KG, Ispringen.

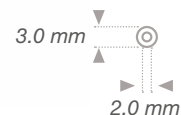

## Hinge 44 with slotted screw

For treatment of class II cases with removable or cemented splints.  
Laser-welded retention (44 mm) ensures secure anchorage in the splints, without stop.

<b>//</b> Hinge 44 kit 1 pair of hinges and 4 pairs of fastening elements	<b>5490.1</b> 1 kit
<b>//</b> Fastening elements with retention, for hinge system, 44 mm 4 pairs of fastening elements	<b>5489.1</b> 4 pairs

CE 0044



## Activator tubes

For insertion of face bows in individually curved Adams clasps, double-sided stable laser welding.

<b>//</b> 1.15/4.5 mm with wire 0.7 mm sh Inner diameter 1.15 mm/.045", length 4.5 mm Wire: 0.7 mm spring hard, length 125 mm	<b>2470.1</b> 10 pieces
<b>//</b> 1.15/6 mm with wire 0.8 mm sh Inner diameter 1.15 mm/.045", length 6.0 mm Wire: 0.8 mm spring hard, length 125 mm	<b>2471.1</b> 10 pieces
<b>//</b> 1.15/6 mm with wire 1.0 mm h Inner diameter 1.15 mm/.045", length 6.0 mm Wire: 1.0 mm hard, length 125 mm	<b>2472.1</b> 10 pieces

CE



## Activator tubes acc. to Teuscher

Polymerisable fixation for face-bows.

<b>//</b> Ø 1.30 mm / .051" Inner diameter: 1.30 mm / .051"	<b>2434.1</b> 10 pieces
<b>//</b> Ø 1.15 mm / .045" Inner diameter: 1.15 mm / .045"	<b>2436.1</b> 10 pieces

CE



## Accessories

Learn more:



### Silicone tube

For covering clasp wires.

// Ø 1.0 inner / 2.0 mm outer

3211.1  
1 m

CE



### Angle tester acc. to Adamik

For fixing and controlling the insertion angle of guiding bars and screws for protrusive double plates.

// Angle tester acc. to Adamik

2332.1  
1 piece



### Symmetry measurement gauge

6 mm acrylic glass plate with mounting pins for exact positioning on the raphe palati. 2 mm grid allows precise determination of sagittal and transversal asymmetries of dental arch length and width.

// Symmetry measurement gauge

8431.1  
1 piece



## CETRON® Cleaning powder

Mild powder for long lasting care and cleaning of orthodontic plates, splints, dentures and sports mouth guards. Powder is dissolved in 150 ml water and can be used for 3-4 days. Not suitable for prosthetic works from polyamide such as Valplast or Breflex.



// 15 g, German	3237.1 5 bags	3237.2 25 bags	3237.3 250 bags
// 15 g, English	3239.1 5 bags	3239.2 25 bags	3239.3 250 bags



## CETRON® Care spray

Care and cleaning of splints, dentures, orthodontic plates, sports mouthguards and anti-snoring appliances. Fresh lemon taste reduces typical monomer taste, ensuring highly polished appliances and high wearing comfort at the same time.

// CETRON® Care spray	3238.1 75 ml
-----------------------	-----------------



### CETRON® Care set

Hygienic and long lasting care and cleaning of splints, dentures, orthodontic plates, sports mouthguard and snoring appliances.

**//** CETRON® Care set **3236.1**  
 incl. cleaning box, brush and 5 bags CETRON® cleaning powder of 15 g 1 set



### Retainer boxes

For orthodontic appliances or BIOPLAST® sports mouth guards. Available in blue, yellow, green, red and violet.

**//** Retainer boxes **5435.1**  
 10 pieces (5 colours, 2 each) 10 pieces





# CA<sup>®</sup> CLEAR ALIGNER



The right concept for every demand.

**Many things are different with CA<sup>®</sup> CLEAR ALIGNER:** the shape of the splint, the material thickness... But the most essential difference: It's up to you to decide – holding the complete value creation in your hands or calling for the services of CA DIGITAL. CA<sup>®</sup> CLEAR ALIGNER leaves you all the options.

More than 600,000 patients have been successfully treated with CA<sup>®</sup> CLEAR ALIGNER – a significant number and above all a wide diversity of experience. For more information visit [www.ca-clear-aligner.com](http://www.ca-clear-aligner.com).

CA <sup>®</sup> Foils.....	50	Interproximal enamel reduction.....	55
Screws and wires.....	51	Accessories.....	57
CA <sup>®</sup> TIP Pliers.....	53	Technical literature.....	59

# CA® Foils

## CA® Foil

High-quality, transparent, hard-elastic material for gentle tooth alignment with aesthetic splints in the CA® system. Material with original CA® labelling stating the thickness: extra soft (0.4 mm), soft (0.5 mm), medium (0.625 mm) and hard (0.75 mm).

// extra soft, 0.4 x 125 mm	<b>3441.1</b> 10 pieces	
// soft, 0.5 x 125 mm	<b>3405.1</b> 10 pieces	<b>3405.2</b> 100 pieces
// medium, 0.625 x 125 mm	<b>3406.1</b> 10 pieces	<b>3406.2</b> 100 pieces
// hard, 0.75 x 125 mm	<b>3407.1</b> 10 pieces	<b>3407.2</b> 100 pieces

CE 0044



CA® CLEAR ALIGNER



## CA® Pro

**New**

Three-layer aligner material with flexible elastomer core in a hard-elastic double shell which is able to maintain a constant force level at a minimal loss of power. The flexible elastomer layer ensures high elasticity and break resistance, while reducing initial force and increasing patient comfort. CA® Pro can be used as single-splint aligner material and within the 3-splint-system according to the CA® protocol.

// 0.5 x 125 mm	<b>3640.1</b> 10 pieces
// 0.625 x 125 mm	<b>3641.1</b> 10 pieces
// 0.75 x 125 mm	<b>3642.1</b> 10 pieces

CE

## CA® Pro+

**New**

Three-layer aligner material with flexible elastomer core in a hard-elastic double shell which is able to maintain a constant force level at a minimal loss of power. The flexible elastomer layer ensures high elasticity and break resistance, while reducing initial force and increasing patient comfort. CA® Pro+ can be used as single-splint aligner material and within the 3-splint-system according to the CA® protocol.

Comes with integrated insulation foil.

// 0.5 x 125 mm	<b>3644.1</b> 10 pieces
// 0.625 x 125 mm	<b>3645.1</b> 10 pieces
// 0.75 x 125 mm	<b>3646.1</b> 10 pieces

CE





## CA® Retention foil pd

CA® Retention foils for long-term use, pre-dried and individually vacuum sealed. Material with original CA® labelling stating the thickness (0.75 and 1.0 mm).

// 0.75 x 125 mm

**3438.1**  
10 pieces

// 1.0 x 125 mm

**3440.1**  
10 pieces

CE 0044

## Screws and wires

### VECTOR® 30

Special miniaturised sector screw with bright yellow directional arrow for single tooth movements. To ensure safe anchorage, retention wires (CHROMIUM Ø 0.8 mm, not included) can be individually inserted and adjusted. Can also be used in the CA® CLEAR ALIGNER technology for oblique-lateral segment expansion acc. to Dr. Pablo Echarri in conjunction with a CHROMIUM wire (0.8 mm) and two VECTOR® 30 screws.

Comes with key for expansion screws.



// special sector screw  
4.80 x 2.60 x 9.50 mm  
Expansion 3.0 mm

**2484.1**    **2484.2**  
2 pieces    10 pieces

CE

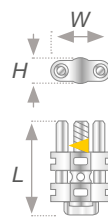

### VECTOR® 40 acc. to Prof. Hinz

Special miniaturised screw with black directional arrow for fabrication of CA® splints, allowing expansions in the lower jaw (up to 3 mm). The retention arms ensure safe anchorage with self-curing curing resin.

// special screw micro  
3.60 x 2.50 x 19.00 mm  
Expansion 3.0 mm

**2486.1**    **2486.2**  
10 pieces    50 pieces

CE



## New: 45 M

### VECTOR® 45 / 45 M acc. to Prof. Hinz

Miniaturised expansion screw with bright yellow directional arrow for fabrication of CA® splints, allowing activation and fan-type expansion (up to 3 or 6 mm). Comes with elongated guiding pins for secure anchorage with cold cure resin and torsion-free expansion. In particular for use in the upper jaw.

<p>/// VECTOR® 45 acc. to Prof. Hinz 4.70 x 2.50 x 19.00 mm Expansion 3.0 mm</p>	<p><b>2487.1</b> 10 pieces</p>
<p>/// VECTOR® 45 M acc. to Prof. Hinz 4.70 x 2.50 x 19.00 mm expansion 6.0 mm</p>	<p><b>2488.1</b> 10 pieces</p>



CE

### CA® Distalizer kit acc. to Dr. Echarri

Kit for the fabrication of a CA® Distalizer acc. to Dr. Echarri for one and double-sided distalisation of molars.

All components available separately, for article numbers please refer to instruction.

<p>/// CA® Distalizer kit acc. to Dr. Echarri 1 CA® pressure spring, 1 CA® guiding rod, 1 CA® telescope sleeve with silicone tube, 1 VECTOR® 350 with key for expansion screws</p>	<p><b>5319.1</b> 1 kit</p>
--	--------------------------------



CE



### TFA-Kit acc. to Dr. Echarri

Kit for the fabrication of a TFA splint (Tractive Force Appliance) acc. to Dr. Echarri for space closure of posterior teeth.

All components available separately, for article numbers please refer to instruction.

<p>/// TFA-Kit acc. to Dr. Echarri traction 3.0 mm</p>	<p><b>5329.1</b> 1 kit</p>
--	--------------------------------



CE



# CA<sup>®</sup> TIP Pliers

Learn more:



## CA<sup>®</sup> TIP 1

Large spherical tip allows insertion of retention points in CA<sup>®</sup> splints, for increase of friction. Stainless steel, sterilisable.

Warranty: 5 years.

// CA<sup>®</sup> TIP 1  
hemisphere: Ø 1.45 mm

5281.1  
1 piece

CE



## CA<sup>®</sup> TIP 2

Small spherical tip allows forming of activation points in CA<sup>®</sup> splints. Stainless steel, sterilisable.

Warranty: 5 years.

// CA<sup>®</sup> TIP 2  
hemisphere: Ø 1.0 mm

5291.1  
1 piece

CE



## CA<sup>®</sup> TIP 3

Pliers with oval plateau, enable creation of activation surfaces in CA<sup>®</sup> splints. Stainless steel, sterilisable.

Warranty: 5 years.

// CA<sup>®</sup> TIP 3  
oval plateau: 3.6 x 1.5 mm

5292.1  
1 piece

CE



## CA® TIP 4

Pliers for torque control with curved plateau, enable creation of labial /lingual activation surfaces in CA® splints. Stainless steel, sterilisable.

Warranty: 5 years.

CA® TIP 4  
curved plateau: 4.0 x 2.5 mm

5295.1  
1 piece

CE



## CA® TIP 5

Pliers for aligners with angled pliers head for correction of splint edges in case of gingival pressure marks. Stainless steel, sterilizable.

Warranty: 5 years.

CA® TIP 5

5299.1  
1 piece

CE



## CA® TIP 6

Pliers for aligners for removal of activation points and surfaces inserted by means of CA® TIP 2, 3 and 4. Also suitable for finishing and smoothing of the splint surface. Stainless steel, sterilizable.

Warranty: 5 years.

CA® TIP 6

5323.1  
1 piece

CE



# Interproximal Enamel Reduction

## CA® Strip Opener

Instruments for opening an interdental gap in case of extreme crowdings, sterilizable, diamond coated on both sides, very thin and with serrated incisal edge. For use before carrying out an interproximal enamel reduction (IER) with CA® Stripping Tools, available with diamond particle size of 15 µm or 40 µm.

CA® Strip Opener should always be used with an oscillating EVA handpiece.

// 15 µm, double-sided diamond coating  
orange, blade thickness approx. 0.09 - 0.15 mm **5326.1**  
1 piece

// 40 µm, double-sided diamond coating  
red, blade thickness approx. 0.175 - 0.235 mm **5327.1**  
1 piece

CE

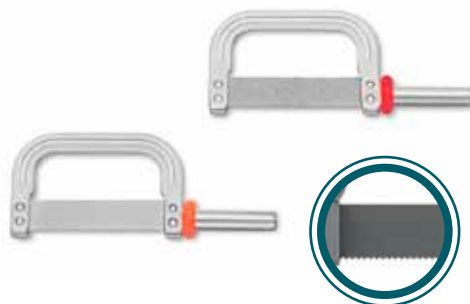

Learn more:



## CA® Stripping Tool

Instruments for interproximal enamel reduction (IER), diamond coated on one or both sides, available in 12 versions. Coating on left, right or both sides. Additional CA® Stripping Tool (15 µm) with extremely fine and smooth diamond coating on both sides available for polishing. CA® Stripping Tools with 90µm diamond particle size (green) shall not be used for enamel removal, only for reduction of fillings and crowns.

Use CA® Stripping Tools either with an EVA hand piece or a sterilisable stainless steel holder.



// 90µm, diamond coating left, green **5342.1**  
1 piece

// 90µm, diamond coating right, green **5343.1**  
1 piece

// 90µm, double-sided diamond coating, green **5344.1**  
1 piece

// 60µm, diamond coating left, grey **5345.1**  
1 piece

// 60µm, diamond coating right, grey **5346.1**  
1 piece

// 60µm, double-sided diamond coating, grey **5347.1**  
1 piece

// 40µm, diamond coating left, red **5348.1**  
1 piece

// 40µm, diamond coating right, red **5349.1**  
1 piece

// 40µm, double-sided diamond coating, red **5350.1**  
1 piece

// 25µm, diamond coating left, white **5351.1**  
1 piece

// 25µm, diamond coating right, white **5352.1**  
1 piece

// 25µm, double-sided diamond coating, white **5353.1**  
1 piece

// 15µm, double-sided diamond coating, yellow **5354.1**  
1 piece

CE

## Stainless steel holder

With straight and angled attachment for secure handling of CA® Stripping Tools without EVA hand piece, sterilizable.

Can also be used for all other instruments with shaft diameter of 2.35 mm.

Stainless steel holder

5358.1  
1 piece



## ECHARRI PST Set

Set acc. to Dr. Pablo Echarri for use in the progressive stripping therapy (PST) containing CA® Stripping Tools with double-sided diamond coating in five diamond particle sizes. Ensures a very smooth enamel finish using an EVA handle. Autoclavable.

CA® Stripping Tools with 90µm diamond particle size (green) shall not be used for enamel removal, only for reduction of fillings and crowns.

ECHARRI PST Set

comes in aluminium case containing 1 x CA® Stripping Tool in 90 µm (green), 60 µm (grey), 40 µm (red), 25 µm (white) and 15 µm (yellow), double-sided diamond coating and CA® Gauge

5341.1  
1 set



## CA® Gauge

Set of stainless steel for control of enamel reduction. Autoclavable up to max. 135° Celsius.

0.1 - 0.5 mm

5316.1  
1 piece





# Accessories

Learn more:



## CA® Splint bags

Resealable write-on minigrip bags for passing on the CA® splints to the patient.

// CA® Splint bags

5283.1  
100 pieces



## CA® Splint case for patients

Handy zipped case for storing and carrying CA® splints. Resealable and write-on CA® splint bags for passing on the CA® splints to the patient. Splint remover for easy removal of pressure moulded splints.

// CA® Splint case for patients  
comes with CA® Travel Case, 3 CETRON® cleansing powder bags  
of 15 g, 3 CA® splint bags, splint remover

5282.1  
1 piece



## CA® Travel Case

Retainer box for up to two CA® CLEAR ALIGNER splints. Specific shape to fit easily into purse or luggage. Detachable lid with additional space for expansion key, two ventilation holes.

// CA® Travel Case

5303.1  
1 piece



## CA® FLASH

For insulation and easy removal when fabricating pressure moulded CA® splints. CA® FLASH is applied to ISOFLAN® foil prior to pressure moulding.

// CA® FLASH  
100 ml pump spray bottle, without propellant gas

5308.1  
100 ml



## CA® POWER GRIP set

CA® POWER GRIP silicone forms enable the fabrication of individual attachments for the CA® CLEAR ALIGNER technology. The set contains nine different moulds that can be filled with light-curing composite for direct application on the prepared tooth as well as two appropriate stainless steel holders for positioning CA® POWER GRIP moulds.

<p>CA® POWER GRIP set incl. 2 holders and 18 silicone moulds (9 versions, 2 pieces each), instructions and CD</p>	<p>5338.1 1 kit</p>
---	-------------------------

CE



## CA® Plastic buttons

Transparent plastic buttons allow placing elastics in the treatment of class II and III.

<p>CA® Plastic buttons</p>	<p>5301.1 4 pieces</p>	<p>5301.2 40 pieces</p>
----------------------------	----------------------------	-----------------------------

CE



## CA® Cyano Veneer Fast / CA® Pipettes

Crystal-clear, fast-curing bonding agent for adhesion of CA® plastic buttons on CA® splints, can also be used for secure adhesion of screws on IST® appliances. CA® pipettes for precise dosing of adhesive.

<p>CA® Cyano Veneer Fast</p>	<p>5302.1 5 g</p>
------------------------------	-----------------------

<p>CA® Pipettes</p>	<p>5300.1 25 pieces</p>
---------------------	-----------------------------

CE



## CA® Coloured pencils

Coloured pencils for marking the CA® measuring points on hard plaster models, with red and blue lead.

<p>CA® Coloured pencils</p>	<p>5290.1 2 pieces</p>
-----------------------------	----------------------------



## Splint Remover

Using the splint remover, the patient can easily remove aligners or pressure moulded splints.

// Splint Remover

5359.1  
5 pieces



## ECHARRI Template kit

Comes with ECHARRI Ceph template, ECHARRI Arch template and ECHARRI VTO templates. Detailed instructions available on [www.scheu-dental.com](http://www.scheu-dental.com).

// ECHARRI Template kit

8435.1  
1 piece



## Technical literature

### CA® Book, volume 1

CA® Book by Dr. Pablo Echarri on CA® splint therapy with detailed description of the CA® CLEAR ALIGNER treatment concept including diagnosis, indication and fabrication. More than 430 pages with many coloured illustrations.

// German

5298.1  
1 piece

// English

5305.1  
1 piece



Learn more:



### CA® Book Advanced, volume 2

Complements volume 1, for advanced users. With advanced therapeutic options of the CA® CLEAR ALIGNER system and survey of the state-of-the-art in CA® CLEAR ALIGNER technology, such as Progressive Stripping Therapy (PST), CA® POWER GRIP moulds No.1 - 9, VECTOR® 30, CA® Distalizer Kit acc. to Dr. Echarri, digital technology, extraction cases and combined therapy. More than 250 pages with many coloured illustrations.

// German

5307.1  
1 piece

// English

5309.1  
1 piece





# CAD / CAM



## Having the future in sight.

**Universal and reliable:** Together with pro3dure medical GmbH and Australian 3D printing specialist ASIGA Pty. Ltd., we have managed to develop the IMPRIMO® system into a complete solution offering you a consistent process flow including 3D printing, cleaning and light curing. Whether for beginners, for advanced users or professionals – the IMPRIMO® system with

its tailored range of devices, consumables and accessories meets any demand in medical 3D printing. It goes without saying that we support you individually with the set-up and the use of the devices as well as the peripheral equipment. Please contact us; we will be glad to assist you.

3D Printing .....	62	3D Software .....	70
IMPRIMO® LC resins for 3D printing .....	67	Milling technology .....	71

# 3D Printing

Learn more:



## Asiga MAX™

With DLP technology and maximum ease of use, the Asiga MAX™ printer allows for fast, precise and efficient operation. The built-in LCD panel with touch function displays the information on the current construction process and allows interactive control of the printer. The light sensor provides consistent projector performance and uniform resin curing, the smart positioning system (SPS™) ensures precise printing results. Print jobs can be stored in a queue, started from the control panel and transmitted via Ethernet or WiFi. The printer can also operate as a wireless hot spot.

### Technical data

Build volume (X, Y, Z): 119 x 67 x 76 mm  
Pixel size: 62 µm  
Image technology: DLP  
Light source: UV LED projector with HD chip  
Wave length: 385 nm  
Voltage: 100 - 240 V, 50/60 Hz  
Power: 500 W  
Consistent data formats: STL, SLC, STM  
Dimensions (w x d x h): 260 x 380 x 370 mm

// Asiga MAX™

6501.1  
1 piece

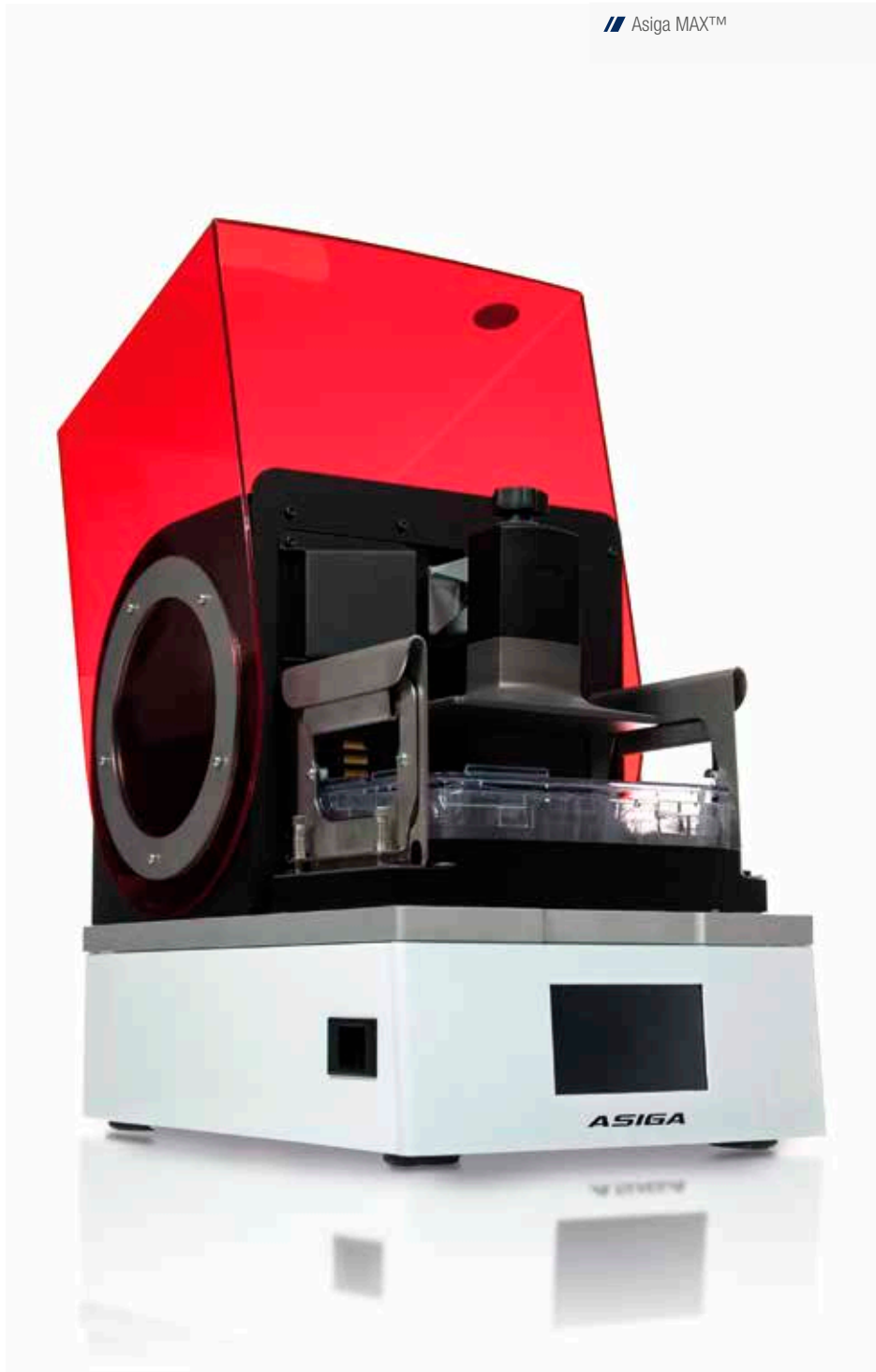

## Asiga PRO 4K

Asiga PRO 4K is a floor-standing 3D printer utilizing the latest DLP imaging technology and combining precision, reliability and speed for high print volumes in the most demanding production applications. Equipped with 4K mode to reduce pixel size, the Asiga PRO 4K can print up to 21 dental arches per print job within one hour and a maximum of 54 dental arches in three layers within less than four hours. In addition to the proven SPST™ sensor-based positioning system, the anti-aliasing system for automatic edge smoothing and the multirange tool for optimising print time, the Asiga PRO 4K offers the usual user-friendly features such as Asiga Composer software, touchscreen display, easy user interface, WiFi and remote control via web interface..

Asiga PRO 4K is available in two versions that differ in pixel resolution (65 or 80 µm) and thus build volume.

### Technical data

Build space (X, Y, Z): 177 x 99 x 200 mm (Asiga PRO 4K65) /  
217 x 122 x 200 mm (Asiga PRO 4K80)

Pixel size: 65 µm without/46 µm with 4K mode for Asiga PRO 4K65  
80 µm without/56 µm with 4K mode for Asiga PRO 4K80

Layer thickness: continuously adjustable from 25 -150 µm

Image technology: DLP

Light source: high power UV LED projector with 4K chip

Wavelength: 385 nm

Voltage source: 100 - 240 V, 50/60 Hz

Power: 600 W

File input: STL, SLC, STM

Dimensions (d x w x h): 475 x 540 x 1,375 mm

// Asiga PRO 4K65

**6538.1**  
1 piece

// Asiga PRO 4K80

**6539.1**  
1 piece



## Asiga MAX™ Tray

The tray system of the Asiga MAX™ allows for easy changing and refilling of materials. Four trays with maximum print capacity of 1l, 2l, 5l or 10l and a maximum fill level of 300 to 400 ml per application are available. Equipped with RFID chip for recording the object volume generated during the print job. It is not possible to use the tray exceeding the maximum print volume.

// 2l	<b>6515.1</b> 1 piece
// 1l	<b>6516.1</b> 1 piece
// 5l	<b>6517.1</b> 1 piece
// 10l	<b>6518.1</b> 1 piece



**New**

## Tray Box Asiga MAX™

Plastic box made of opaque material for storing filled trays of the Asiga MAX™ printer. The printer resin can remain in the trays during storage as it does not harden inside the opaque box. With write-on lid allowing simultaneous storing of several boxes.

// Tray Box Asiga MAX™

**6552.1**  
1 piece

## Asiga PRO Tray

The tray system of the Asiga PRO 4K printers ensures easy changing and refilling of materials. It includes three different trays with a maximum print capacity of 2l, 5l or 10l. With RFID chip for recording the object volume generated during the printing process. It is not possible to use the tray beyond its maximum print volume.

// 2l	<b>6521.1</b> 1 piece
// 5l	<b>6523.1</b> 1 piece
// 10l	<b>6524.1</b> 1 piece





**New**

## RS wash

The fully automated cleaning device makes cleaning your 3D printed parts safe and easy by removing sticky residues in a pre- and post cleaning process with final drying that takes approximately 6 - 8 minutes. For a perfect finish, the consumption of the cleaning liquid is optimized to a minimum level without affecting the cleaning quality.

### Technical data

Voltage: 24 V

Power: 120 W

Dimensions: 230 x 270 x 450 mm

Cleaning chamber: 130 x 75 x 60 mm

(800 ml capacity cleaning cartridges)

Network compatibility: WLAN/LAN

Touch panel: 5.8"



// RS wash

**6536.1**  
1 piece

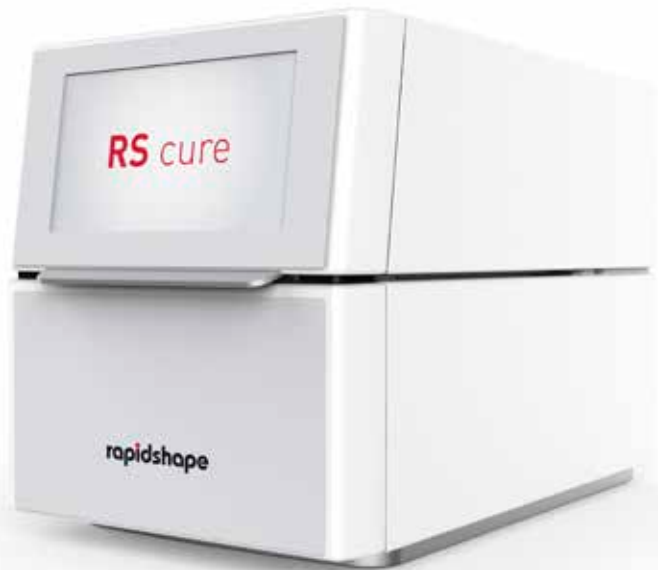

**New**

## RS cure

Light curing unit for the polymerisation of 3D-printed parts in only 4-12 minutes. The powerful LEDs used in the exposure system ensure 360° homogeneous curing in the UVA and UVB range in combination with either vacuum or inert gas.

### Technical data

Voltage: 24 V

Power: 220 W

Dimensions: 230 x 270 x 380 mm

UV chamber: 130 x 75 x 60 mm

Network compatibility: WLAN/LAN

Touch panel: 5.8"

// RS cure

**6535.1**  
1 piece

## High cleaning power

### IMPRIMO® Cleaning Liquid

Water-soluble cleaning agent for removal of resin residues on 3D printed objects. For use in cleaning devices such as RS wash and ultrasonic baths, ultra-filterable and non-flammable. Cleaning effect up to 5 times higher than isopropanol.

IMPRIMO® Cleaning Liquid

6533.1  
1 l



## New

### IMPRIMO® Model Separator

Water-based, blue-transparent gel for the insulation of 3D-printed models in the fabrication of removable orthodontic appliances. By forming an even film on the model, an optimal insulating effect is ensured between IMPRIMO® LC printer resins and STEADY-RESIN self-curing resins.

Apply thinly with a brush and allow to dry thoroughly. Not suitable for 3D models generated by a filament printer.

Available as 100 ml pump bottle incl. brush or as refill in 500 ml refill bottle. STL data set for 3D printing of rack for pump bottle and brush available as download.

Contains no volatile organic solvents. Product is not hazardous in terms of the transport guidelines.

IMPRIMO® Model Separator

6551.1 6551.2  
100 ml 500 ml



### 3D Model insulation

Insulating agent for 3D-printed models when processing self-curing resins, such as STEADY-RESIN S and IMPRIMO® LC printer resins. Application with the enclosed brush results in an optimal insulating effect, which is achieved by forming a thin layer of micro wax beads on the model surface. Not suitable for 3D models from a filament printer.

For extraoral use only.

Product is not hazardous in terms of transport guidelines.

3D Model insulation

6510.1  
65 ml



# IMPRIMO® LC resins for 3D printing

Together with pro3dure medical GmbH we have developed an extensive portfolio of light-curing, methacrylate-based building materials covering a variety of dental applications. Materials are matched to the Asiga 3D printers and suitable for DLP systems with a light source of 385 nm. Please refer to the table in the annex for the technical data of the materials.

Learn more:



## IMPRIMO® LC Model

Light-curing, methacrylate-based resin for fabrication of high-precision dental models with smooth surfaces. Available in three colours for orthodontic and prosthetic applications, adapted to DLP systems with a light source of 385 nm. For fabrication of orthodontic expansion plates on 3D-printed models, the use of IMPRIMO® Model Separator (REF 6551) for insulation is recommended.

// ivory, DLP / 385 nm **6502.1**  
1 kg

// grey, DLP / 385 nm **6504.1**  
1 kg

// beige, DLP / 385 nm **6505.1**  
1 kg



## IMPRIMO® LC Splint

Light-curing, methacrylate-based resin for fabrication of high-precision, transparent occlusal splints and surgical drilling guides. When cured, the resin is characterised by relative flexibility and provides high wearing comfort, reduced susceptibility to breakage and excellent polishing properties. Contains no diluting monomers, compatible with DLP printing systems with 385 nm light source.

// transparent, DLP / 385 nm **6503.1**  
1 kg

CE 0044



**New**

## IMPRIMO® LC Splint flex

The new light-curing, methacrylate-based resin is indicated for fabrication of high-precision, transparent occlusal splints as well as for bruxism and lower jaw protrusion splints. Thermo-active memory effect ensures perfect material fitting. When cured, the resin is characterised by high flexibility and provides high wearing comfort, reduced susceptibility to breakage and excellent polishing properties. Contains no diluting monomers, compatible with DLP printing systems with 385 nm light source.

// transparent, DLP / 385 nm **6525.1** **6525.2**  
500 g 1 kg

CE 0044





### IMPRIMO® LC Impression

Light-curing, methacrylate-based resin for fabrication of individual functional trays and bases for bite registrations, neon orange. Compatible with DLP systems with a light source of 385 nm.

// orange, DLP / 385 nm

**6506.1**  
1 kg



### IMPRIMO® LC IBT

Light-curing, flexible resin for fabrication of transfer masks in the indirect bonding technique, transparent. Compatible with DLP systems with a light source of 385 nm.

// transparent, DLP / 385 nm

**6508.1**  
1 kg



### IMPRIMO® LC Cast

Light-curing resin, castable and burning out residue-free, for fabrication of dental casting objects, red. Adapted to DLP systems with a light source of 385 nm.

// red, DLP / 385 nm

**6507.1**  
1 kg



## IMPRIMO® LC Gingiva

Light-curing, flexible resin for fabrication of gingival masks, rose. Compatible with DLP systems with a light source of 385 nm.

// rose, DLP / 385 nm

**6509.1**  
1 kg



## IMPRIMO® LC Try-In

Light-curing, methacrylate-based resin for functional try-ins of digitally planned denture bases. For control of bite registration and occlusion, available in tooth shades VITA classical A1, A2 and A3. Compatible with DLP systems with a light source of 385 nm.

// A1, DLP / 385 nm

**6541.1**  
1 kg

// A2, DLP / 385 nm

**6542.1**  
1 kg

// A3, DLP / 385 nm

**6543.1**  
1 kg

CE

## IMPRIMO® LC Denture

Light-curing, methacrylate-based resin assigned to Class IIa of the MDD destined for fabrication of denture bases, available in three gingiva colour shades. All requirements for dental products relating to water absorption ( $25.8 \mu\text{g}/\text{mm}^3$ ) and water solubility ( $0,41 \mu\text{g}/\text{mm}^3$ ) according to ISO 20795-1: 2013 are met. Low shrinkage ( $< 1 \%$ ) guarantees perfect fit. Outstanding polishability, compatible with DLP printing systems with 385 nm light source.

// orange pink, DLP / 385 nm

**6540.1**  
1 kg

// light pink, DLP / 385 nm

**6547.1**  
1 kg

// deep pink, DLP / 385 nm

**6548.1**  
1 kg



CE 0044



## IMPRIMO® LC Temp

Light-curing, methacrylate-based resin assigned to Class IIa of the MDD for fabrication of temporary front teeth restorations, characterized by high abrasion and breaking resistance. The resin allows preparing of bridges with a maximum of one pontic that can be fastened using temporary cements. Make sure to pay attention to the adjoining areas. High aesthetics in tooth shades VITA classical A1, A2 and A3. The temporaries can be fastened with temporary cements. Compatible with DLP systems with a light source of 385 nm.

// A1, DLP / 385 nm	<b>6527.1</b> 1 kg
// A2, DLP / 385 nm	<b>6528.1</b> 1 kg
// A3, DLP / 385 nm	<b>6529.1</b> 1 kg

CE 0044

## IMPRIMO® LC Temp It

Light-curing, methacrylate-based resin assigned to Class IIa of the MDD in long-term version – with higher filler content for fabrication of long-term temporaries such as crowns and bridges (with one pontic) as well as mock-ups. Make sure to pay attention to the adjoining areas. High abrasion and breaking resistance and high aesthetics in tooth shades VITA classical A1, A2 and A3. The temporaries can be fastened with temporary cements. Compatible with DLP systems with a light source of 385 nm.

// A1, DLP / 385 nm	<b>6544.1</b> 1 kg
// A2, DLP / 385 nm	<b>6545.1</b> 1 kg
// A3, DLP / 385 nm	<b>6546.1</b> 1 kg

CE 0044



## IMPRIMO® LC MJF

Light-curing, methacrylate-based and hemocompatible resin for fabrication of appliances in oral and maxillofacial surgery and implantology. Suitable for the usual sterilization methods such as plasma, autoclave, gamma radiation and ethylene oxide sterilization. This unique blood compatible material offers a range of applications with an extremely high standard of biocompatibility, such as for example surgical drilling templates or NAM-plates. Compatible with DLP systems with a light source of 385 nm.

// transparent, DLP / 385 nm	<b>6526.1</b> 1 kg
------------------------------	-----------------------

CE 0044



## Milling blank for thermoplastic splints

### DURASPLINT® flex

MMA-free material for the fabrication of functional occlusal splints with thermoplastic memory effect. The material is flexible at body temperature, leading to an increased wearing comfort. At the same time, the material is characterized by a high restoring torque at room temperature, high breaking resistance, durability and permanent transparency. The unique manufacturing process guarantees permanent tastelessness of the finished splints. Available as milling blank in thicknesses of 16 and 20 mm and as cold-curing resin for use in the casting and pressing techniques.



// 16 mm milling blank  
Ø 98.5 mm

**3619.1**  
1 piece

// 20 mm milling blank  
Ø 98.5 mm

**3620.1**  
1 piece

CC 0044







# Dental Sleep Medicine

More quality of life.

**We assure restful sleep.** Trust in the market leader in dental sleep medicine. The IST® and TAP® appliances set the standard for successful treatment of snoring and sleep apnoea. We recommend

our ACADEMY courses on indication and fabrication of these devices.

IST® and OPM .....	74	Bite registrations and occlusion trainer .....	82
TAP® Anti-snoring devices .....	76	Accessories .....	84



## IST® Kit HF 9

Intra-oral anti-snoring device, pressure-moulded. Connection between upper and lower jaw is achieved by continuously adjustable HF telescope. Lower jaw and tongue are advanced by protrusion.

### IST® Kit HF 9

incl. 2 telescopes, 4 DURAN® (2.0 mm), 4 ISOFOLAN®, DURASPLINT® resin, 4 fastening elements with O-ring, 4 SCHEU-anchor, Alastik chain, silicone tube, security key, SD box for patient, occlusion trainer, 2 CETRON® cleaning powder bags of 15 g, instructions and patient information

**5461.1**  
1 kit

CE 0044

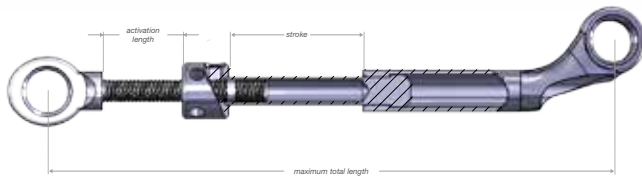
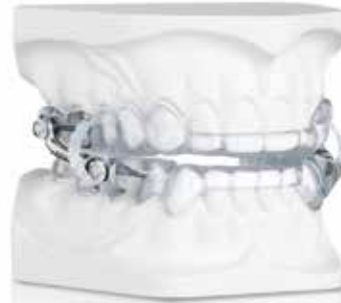

	Minimum length	Maximum length	Stroke	Length to be activated	$4 \times \frac{1}{4}$
HF 5	20 mm	28 mm	5 mm	3 mm	0.25 mm
HF 9	25 mm	39 mm	9 mm	5 mm	0.25 mm
HF 15	31 mm	51 mm	15 mm	5 mm	0.25 mm

## Telescopes

Telescopes with limit stop, available in 3 sizes (HF 5, HF 9 and HF 15), continuously adjustable. Come with key for expansion screws.

### HF 5

**5449.1**  
1 pair

### HF 9

**5454.1**  
1 pair

### HF 15

**5444.1**  
1 pair

CE 0044

## Positioning aid for IST® (12° / 0°)

For simple and correct positioning of the IST® fastening elements.

### Positioning aid for IST® (12° / 0°)

**5469.1**  
1 piece



## Fastening elements for IST® appliance

With stable retention, come with O-rings.

// Fastening elements for IST® appliance  
incl. silicone tube

**5468.1**  
4 pairs

CE 0044



## Fastening elements for IST® and Herbst appliances

With stable retention, come with hexagon screws.

// Fastening elements for IST® and Herbst appliances  
incl. silicone tube

**5457.1**  
4 pairs

CE 0044



## Hexagon socket screws

Spare screws for fastening elements.

// Hexagon socket screws  
for IST® appliance

**5458.1**  
4 pieces

CE 0044



## O-Rings

Replacement O-rings for IST® appliance, transparent.

// O-Rings  
for IST® appliance

**5466.1**  
10 pieces

CE 0044



## OPM Kit

For simple fabrication of a pressure moulded OPM protrusion splint in snoring therapy. Activation is done in 1 mm steps by replacing the plastic bars on both sides.

// OPM Kit  
incl. 6 pairs of plastic bars (25 - 30 mm long), 4 fastening  
elements with O-rings, 1 bag CETRON® cleaning powder of 15 g,  
occlusion trainer, silicone protection tube

**5495.1**  
1 kit

CE



# TAP® Anti-snoring devices

Intraoral devices have become a renowned supplement in the treatment of snoring and mild to moderate forms of sleep apnea and even represent an alternative to the treatment with respiratory masks (CPAP). TAP® splints meet the requirements of therapists as well as of patients in terms of an effective treatment device in dental sleep medicine.

TAP® kits, components and accessories (except TAP® PAP and myTAP™) are exclusively delivered to certified participants of the TAP® technical course.

Learn more:



## TAP® Standard Kit

Thornton Adjustable Positioner (TAP®), enables a controlled and effective treatment of snoring and sleep apnoea. The TAP® splint has been developed by the American dentist and engineer Dr. Keith Thornton.

// TAP® Standard Kit  
 comes with TAP® front assembly, TAP® lingual bar, TAP® closed hook (u-hook), hexagon wrench, occlusion trainer, 5 bags of CETRON® Cleaning powder of 15g, SD box blue and patient information.

9000.1  
 1 kit

CE



## TAP®-T Kit

Developed on the basis of TAP® Standard in slender design. Nickel-free components for optimum bio-compatibility. Upper protrusion adjustment device can be continuously activated up to 7 mm. Reactivation is possible.

Also available as pre-assembled set (REF 9030.2).

// TAP®-T Kit  
 comes with TAP® case, upper protrusion adjustment device made of titanium, lower guiding device made of nickel-free CoCr-alloy, mounting aid, activation key, occlusion trainer, 5 bags of 15 g CETRON® cleaning powder, CETRON® cleaning box and patient information

9030.1  
 1 kit

// TAP®-T, pre-assembled kit  
 comes with TAP® case, upper protrusion adjustment device made of titanium, pre-assembled with sticky wax, lower guiding device made of nickel-free CoCr-alloy, mounting aid, activation key, occlusion trainer, 5 bags of 15 g CETRON® cleaning powder, CETRON® cleaning box and patient information

9030.2  
 1 piece

CE



## TAP®-T Reverse Kit

The TAP®-T Reverse device incorporates a reduced upper protrusion adjustment device made of titanium. It has been specifically designed for patients with deep bite. Lower protrusion is adjusted by activation key (palatal), as this reduced adjustment device can be inserted behind the upper incisors in the DURASOFT® splint. Reactivation is possible.

Also available as pre-assembled set (REF 9050.2).

// TAP®-T Reverse Kit **9050.1**  
1 kit  
comes with TAP® case, small upper protrusion adjustment device made of titanium, lower guiding device made of nickel-free CoCr-alloy, mounting aid, activation key, occlusion trainer, 5 bags of 15 g CETRON® cleaning powder, CETRON® cleaning box and patient information

// TAP®-T Reverse, pre-assembled kit **9050.2**  
1 kit  
comes with TAP® case, upper protrusion adjustment device made of titanium, pre-assembled with sticky wax, lower guiding device made of nickel-free CoCr-alloy, mounting aid, activation key, occlusion trainer, 5 bags of 15 g CETRON® cleaning powder and patient information

CE



## TAP®-T / TAP®-T Reverse Starter-Set

Simplified mounting thanks to combination of TAP®-T or TAP®-T Reverse upper protrusion adjustment device and TAP®-T lower guiding device, pre-assembled with sticky wax.

// TAP®-T Starter-Set **9031.1**  
1 piece  
set comes with TAP®-T positioning aid, pre-assembled with sticky wax, activation key, SD box blue, patient information

// TAP®-T Reverse Starter-Set **9051.1**  
1 piece  
set comes with TAP®-T Reverse positioning aid, pre-assembled with sticky wax, activation key, SD box blue, patient information

CE

## The new TAP® generation

### dreamTAP™

The dreamTAP™ splint is characterised by a guiding device implemented in the lower jaw, offering additional space for the tongue and thus higher wearing comfort. It is continuously adjustable with interchangeable hooks, enabling protrusion adjustment of up to 15 mm and large lateral excursion. The components are made from a nickel-free CrCo alloy fabricated by MIM (Metal Injection Molding) and thus exceptionally stable.

All components also available separately.

// dreamTAP™  
incl. protrusion adjustment device, short, medium and long hook,  
power distribution wire (0.8 mm) and guide wire (1.2 mm),  
adjustment key, key for hook changes, AM Aligners, storage box,  
patient instructions.

9060.1  
1 kit

CE



## For use in combined therapy

### TAP® PAP

Comfortable nasal pillow mask designed for patients with low CPAP compliance. Since the TAP® PAP mask is anchored to the upper teeth with a special ThermAcryl™ mouthpiece, it is very stable, will not move or leak nor leave annoying marks on nose and face. Lower jaw splint sold separately (TAP® PAP lower tray, REF 9074) for use in combined therapy.

// TAP® PAP  
comes with nasal pillow in small, medium and large

9073.1  
1 piece

CE



### TAP® PAP Lower Tray

Lower jaw protrusion splint for use with TAP® PAP in combined therapy. An advancement of the lower jaw can reduce the pressure exercised by the mask. Comes with lower protrusion splint, screw, AM Aligner and instruction.

// TAP® PAP Lower Tray

9074.1  
1 piece

CE



## myTAP™

Diagnostic testing appliance for getting acquainted with the simple and patient-friendly treatment of snoring and sleep apnoea. Metal-free and easy adjustable trays enable protrusion up to 20 mm, assuring considerable lateral excursion.

// myTAP™ **9070.1**  
upper and lower jaw splint, incl. nut, labial shield, storage box, AM 1 piece  
Aligner and instructions



## TAP® Splint case for patients

Zippered case for storing and carrying TAP® and TAP®-T splints.

// TAP® Splint case for patients **9082.1**  
1 piece



## TAP®-T Mounting device

Auxiliary for easy mounting of TAP®-T upper protrusion adjustment device and TAP®-T lower guiding device.

// TAP®-T Mounting device **9039.1**  
5 pieces



## TAP®-T Matrix

Reusable auxiliary element made of heat-resistant silicone for efficient fabrication of the sticky wax spacer. Makes sure the TAP®-T titan hook runs free in the guiding device in the lower splint.

Not for use with TAP®-T XL lower guiding device.

// TAP®-T Matrix **9037.1**  
2 pieces



# TAP® Components

## TAP® Front assembly

Protrusion adjustment device for TAP® Standard, comes with hexagon socket wrench.

// TAP® Front assembly  
incl. hexagon socket wrench

**9010.1**  
1 piece



## TAP® Mounting device

For easy and correct positioning of the front assembly, comes with socket wrench.

// TAP® Mounting device  
incl. socket wrench

**9016.1**  
1 piece



## TAP® Lingual bar

Replacement TAP® lingual bar for TAP® Standard.

// TAP® Lingual bar

**9013.1**  
1 piece



## TAP® Closed hook

Replacement u-hook for TAP® Standard.

// TAP® Closed hook (u-hook)

**9012.1**  
1 piece



## TAP® Cover plate

Replacement plate set for the TAP® Standard front assembly after adjustment of protrusion.

// TAP® Cover plate  
incl. 2 screws and hexagon key

**9015.1**  
1 piece





## TAP® Locator

Replacement locator, suitable for TAP® Standard.

// TAP® Locator

**9014.1**  
1 piece



## TAP®-T Upper protrusion adjustment device

Replacement protrusion adjustment device, allowing 7 mm protrusion.

// TAP®-T Upper protrusion adjustment device

**9033.1**  
1 piece



## TAP®-T Reverse Upper protrusion adjustment device

Replacement TAP®-T Reverse protrusion adjustment device, allowing 4 mm protrusion.

// TAP®-T Reverse Upper protrusion adjustment device

**9053.1**  
1 piece



## TAP®-T Lower guiding device

Replacement TAP®-T lower guiding device, suitable for TAP®-T and TAP®-T Reverse upper protrusion adjustment device.

// TAP®-T Lower guiding device

**9032.1**  
1 piece



## TAP®-T XL Lower guiding device

Increased version (2 mm additional mobility) for more wearing comfort. Can be used with TAP®-T and TAP®-T Reverse upper protrusion adjustment devices.

// TAP®-T XL Lower guiding device  
incl. matrix

**9029.1**  
1 piece



# Bite Registration and Occlusion Trainer

Learn more:



## Bite Fix®

Bite registration with reusable holder made of sterilizable plastic for simple and precise registration of construction bites in anti-snoring therapy. The decentralized handle assures easy midline control and comes with fixing screw and mm-scale for control of protrusion adjustment.

// Bite Fix®, kit 5474.1  
incl. 1 holder and 1 bite fork 1 kit

// Bite Fix®, bite forks 5475.1  
10 pieces

CE



## Suitable for model scanners

## Bite Fix® Scan

Bite registration with reusable holder made of sterilizable plastic for simple and precise registration of construction bites in anti-snoring therapy. The decentralized handle assures easy midline control and comes with fixing screw and mm-scale for control of protrusion adjustment. Fits into every model scanner thanks to a predetermined breaking point on the bite fork.

// Kit 5492.1  
incl. 1 holder and 1 bite fork 1 kit

// Bite forks 5493.1  
10 pieces

CE



## Bite Fix® One

Bite Fix® bite registration as single-use product, for easy and precise registration of construction bites in the anti-snoring therapy. Non-reusable, not sterilisable.

// Bite Fix® One 5503.1  
1 kit

CE



## Sterilisable body

### GEORGE GAUGE™ bite registration set

For registration of occlusion in snoring therapy and orthodontics. The bite registration is pre-adjusted using 2 or 5 mm bite forks. The body of the GEORGE GAUGE™ bite registration is reusable and sterilisable.

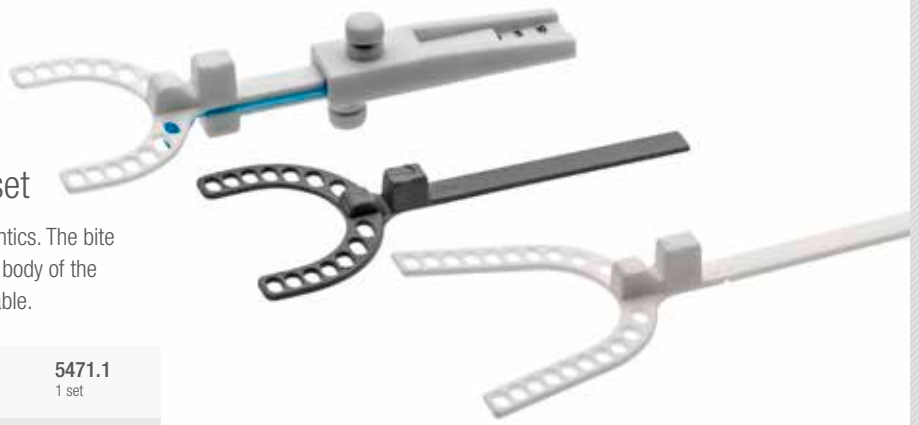

// GEORGE GAUGE™ bite registration set comes with 3 bite forks (1 for each size)	5471.1 1 set
// GEORGE GAUGE™ bite fork, 5 mm, white, large (L)	5462.1 10 pieces
// GEORGE GAUGE™ bite fork, 2 mm, grey, small (S)	5472.1 10 pieces
// GEORGE GAUGE™ bite fork, 5 mm, white, small (S)	5473.1 10 pieces

CE

### AM Aligner

Thermoplastic occlusion trainer for condylar reposition after wearing protrusion splints during the night. The AM Aligner is heated and adapted to the patient's upper jaw by the clinician.

// AM Aligner	9072.1 10 pieces
---------------	---------------------

CE



### Occlusion trainer

Condylar reposition device for patients' training after wearing protrusion splints during the night.

// Occlusion trainer	5470.1 10 pieces
----------------------	---------------------

CE



# Accessories



Learn more:



## CETRON® Care set

Hygienic and long lasting care and cleaning of splints, dentures, orthodontic plates, mouth guard and snoring appliances.

// CETRON® Care set 3236.1  
incl. cleaning box, brush and 5 bags CETRON® cleaning powder of 1 set  
15 g



## CETRON® Care spray

Care and cleaning of splints, dentures, orthodontic plates, mouth guard and snoring appliances. Fresh lemon taste reduces typical monomer taste, ensuring highly polished appliances and high wearing comfort at the same time.

// CETRON® Care spray 3238.1  
75 ml

CE

## CETRON® Cleaning powder

Mild powder for long lasting care and cleaning of orthodontic plates, splints, dentures and sports mouth guards. Powder is dissolved in 150 ml water and can be used for 3 - 4 days. Not suitable for prosthetic works from polyamide such as Valplast or Breflex.

// German	3237.1 5 bags	3237.2 25 bags	3237.3 250 bags
// English	3239.1 5 bags	3239.2 25 bags	3239.3 250 bags



## CLEAR-BLOKKER®

Light-curing, high-transparent gel for adjustments on pressure moulded DURAN® splints, reinforced with DURASPLINT® LC. Gel is best suited for removal of air inclusions and insertion of canine guidance. Polymerisation in wavelength range 360–420 nm, for example using LC-6 Light Oven. Prior to processing, LC primer has to be applied to DURAN® splints.

// 4 x 1.5 g  
incl. 2 cannula Ø 0.4 mm and 8 cannula Ø 0.9 mm

5261.1  
1 piece

CE



## Activation key

Activation key for TAP®-T and TAP®-T Reverse protrusion adjustment device.  
Can also be used for IST® hexagon screws.

// Activation key

9035.1  
1 piece





# Pressure Moulding Technique



More than 50 years of competence and experience.

**Tried and tested.** Our thermoforming materials for medical applications are made of biocompatible and well-tolerated materials. The wide

range of material offers you the right product for any application. A bar code is applied to each blank, making processing quick, easy and safe.

Pressure moulding material .....	88	Finishing and polishing .....	107
Resins, auxiliaries and accessories .....	102		

# Pressure moulding material

Learn more:



## BIOCRYL® C

Break-resistant acrylic material of pure PMMA, monomer-free, without allergenic irritants, bonds to acrylic.

### Application

Immediate dentures, orthodontic plates, retention plates and denture bases.

// 2.0 x 125 mm, clear	3147.1 10 pieces	3147.2 100 pieces
// 2.0 x 125 mm, red-transparent	3149.1 10 pieces	
// 2.0 x 125 mm, blue-transparent	3150.1 10 pieces	
// 2.0 x 125 mm, yellow-transparent	3151.1 10 pieces	
// 2.0 x 125 mm, rose-transparent	3152.1 10 pieces	3152.2 100 pieces
// 3.0 x 125 mm, clear	3153.1 10 pieces	3153.2 100 pieces

CE



## BIOCRYL® Form X

Tough-elastic material, does not bond to acrylic, blue.

### Application

Radiopaque material for the exact visualisation of the clinical situation in computer tomography. The material closely adapts to the tooth surface and its outline is sharply imaged.

// 1.5 x 125 mm, blue

3148.1  
10 pieces

CE





## DURAN®

Hard-elastic transparent material, bonds to cold-curing resins such as DURASPLINT® and DURASPLINT® LC. Apply LC primer prior to using DURASPLINT® LC. Does not require pre-drying.

### Application

Miniplast splints, occlusal splints, interim and fluorisation splints, X-ray templates, anti-snoring appliances, reinforced anterior section of sports mouthguard.

// 0.4 x 125 mm	<b>3470.1</b> 10 pieces	
// 0.5 x 125 mm	<b>3411.1</b> 10 pieces	<b>3411.2</b> 100 pieces
// 0.625 x 125 mm	<b>3409.1</b> 10 pieces	<b>3409.2</b> 100 pieces
// 0.75 x 125 mm	<b>3413.1</b> 10 pieces	<b>3413.2</b> 100 pieces
// 1.0 x 125 mm	<b>3415.1</b> 10 pieces	<b>3415.2</b> 100 pieces
// 1.5 x 125 mm	<b>3417.1</b> 10 pieces	<b>3417.2</b> 100 pieces
// 2.0 x 125 mm	<b>3419.1</b> 10 pieces	<b>3419.2</b> 100 pieces
// 3.0 x 125 mm	<b>3421.1</b> 10 pieces	<b>3421.2</b> 100 pieces

CE 0044



## DURAN®+

Hard-elastic transparent material, bonds to cold-curing resins such as DURASPLINT® and DURASPLINT® LC. Apply LC primer prior to using DURASPLINT® LC. With integrated insulation foil. Does not require pre-drying.

### Application

Miniplast splints, occlusal splints, fluorisation splints, X-ray templates, anti-snoring devices.

// 0.4 x 125 mm	<b>3472.1</b> 10 pieces	
// 0.5 x 125 mm	<b>3426.1</b> 10 pieces	<b>3426.2</b> 100 pieces
// 0.625 x 125 mm	<b>3428.1</b> 10 pieces	<b>3428.2</b> 100 pieces
// 0.75 x 125 mm	<b>3430.1</b> 10 pieces	<b>3430.2</b> 100 pieces
// 1.0 x 125 mm	<b>3432.1</b> 10 pieces	<b>3432.2</b> 100 pieces
// 1.5 x 125 mm	<b>3434.1</b> 10 pieces	<b>3434.2</b> 100 pieces
// 2.0 x 125 mm	<b>3436.1</b> 10 pieces	<b>3436.2</b> 100 pieces

CE 0044

## DURAN®+ A2 pd

Proven DURAN® quality in aesthetic colour (VITA A2), with integrated insulation foil. Already pre-dried and vacuum sealed for instant use.

### Application

Tooth coloured temporaries, splints for planning and demonstration for aligner treatments

// 0.5 x 125 mm	3422.1 10 pieces
// 0.625 x 125 mm	3424.1 10 pieces
// 0.75 x 125 mm	3423.1 10 pieces

CE 0044



## DURAN®+ white pd

Proven DURAN® quality in white (VITA OM1), with integrated insulation foil. Already pre-dried and vacuum sealed for instant use.

### Application

Cosmetic splints

// 0.5 x 125 mm	3473.1 10 pieces
// 0.625 x 125 mm	3474.1 10 pieces
// 0.75 x 125 mm	3475.1 10 pieces
// 1.0 x 125 mm	3476.1 10 pieces

CE

**New**

## CA<sup>®</sup> Pro

Three-layer aligner material with flexible elastomer core in a hard-elastic double shell which is able to maintain a constant force level at a minimal loss of power. The flexible elastomer layer ensures high elasticity and break resistance, while reducing initial force and increasing patient comfort. CA<sup>®</sup> Pro can be used as single-splint aligner material and within the 3-splint-system according to the CA<sup>®</sup> protocol.

// 0.5 x 125 mm	<b>3640.1</b> 10 pieces
// 0.625 x 125 mm	<b>3641.1</b> 10 pieces
// 0.75 x 125 mm	<b>3642.1</b> 10 pieces

CE



**New**

## CA<sup>®</sup> Pro+

Three-layer aligner material with flexible elastomer core in a hard-elastic double shell which is able to maintain a constant force level at a minimal loss of power. The flexible elastomer layer ensures high elasticity and break resistance, while reducing initial force and increasing patient comfort. CA<sup>®</sup> Pro+ can be used as single-splint aligner material and within the 3-splint-system according to the CA<sup>®</sup> protocol.

Comes with integrated insulation foil.

// 0.5 x 125 mm	<b>3644.1</b> 10 pieces
// 0.625 x 125 mm	<b>3645.1</b> 10 pieces
// 0.75 x 125 mm	<b>3646.1</b> 10 pieces

CE



## CA® Foil

High-quality, transparent, hard-elastic material for gentle tooth alignment with aesthetic splints in the CA® system. Material with original CA® labelling stating the thickness: extra soft (0.4 mm), soft (0.5 mm), medium (0.625 mm) and hard (0.75 mm).

// extra soft, 0.4 x 125 mm	<b>3441.1</b> 10 pieces	
// soft, 0.5 x 125 mm	<b>3405.1</b> 10 pieces	<b>3405.2</b> 100 pieces
// medium, 0.625 x 125 mm	<b>3406.1</b> 10 pieces	<b>3406.2</b> 100 pieces
// hard, 0.75 x 125 mm	<b>3407.1</b> 10 pieces	<b>3407.2</b> 100 pieces

CE 0044



## CA® Retention foil pd

CA® Retention foils for long-term use, pre-dried and individually vacuum sealed. Material with original CA® labelling stating the thickness (0.75 and 1.0 mm).

// 0.75 x 125 mm	<b>3438.1</b> 10 pieces
// 1.0 x 125 mm	<b>3440.1</b> 10 pieces

CE 0044

## DURASOFT® pd

Break- and abrasion-resistant, transparent compound material with a hard and soft side. Hard side bonds to acrylic. Already pre-dried and vacuum-sealed for instant use.

### Application

Miniplast splints, bruxism splints, occlusal splints with soft inner side, intra-oral anti-snoring devices, orthodontic splints.

// 1.2 x 125 mm hard / soft: 0.7 mm / 0.5 mm	<b>3342.1</b> 10 pieces	<b>3342.2</b> 100 pieces
// 1.8 x 125 mm hard / soft: 0.9 mm / 0.9 mm	<b>3388.1</b> 10 pieces	<b>3388.2</b> 100 pieces
// 2.5 x 125 mm hard / soft: 1.6 mm / 0.9 mm	<b>3387.1</b> 10 pieces	<b>3387.2</b> 100 pieces
// 3.0 x 125 mm hard / soft: 2.1 mm / 0.9 mm	<b>3341.1</b> 10 pieces	
// 4.0 x 125 mm hard / soft: 3.1 mm / 0.9 mm	<b>3345.1</b> 10 pieces	

CE 0044



## DURASOFT® blue pd

The proven break and abrasion-resistant material in blue-transparent colour. Already pre-dried and vacuum sealed for instant use.

### Application

Specifically designed for simple fabrication of coloured intra-oral anti-snoring devices. Blue colour increases aesthetics.

// 1.8 x 125 mm hard / soft: 0.9 mm / 0.9 mm	<b>3347.1</b> 10 pieces
// 2.5 x 125 mm hard / soft: 1.6 mm / 0.9 mm	<b>3348.1</b> 10 pieces

CE

## DURASOFT® seal

Pressure moulding material made of thermoplastic polyurethane for use with DURASOFT® pd. Forms a robust inner layer and provides high quality hard-soft splints with excellent resistance against discolouration. Available in clear, blue and magenta.

### Application

Discolouration-resistant inner layer for DURASOFT® pd splints. Specifically designed for long-term use splints such as intra-oral anti-snoring devices.

0.1 x 125 mm, magenta	3337.1 10 pieces
0.1 x 125 mm, clear	3338.1 10 pieces
0.1 x 125 mm, blue	3339.1 10 pieces

CE 0044



## BIOPLAST®

Soft-elastic rubber like material, does not bond to acrylic, clear transparent. Hardness Shore A: 85.

### Application

Duplication moulds for situation models, sports mouth guards, bruxism splints, positioners, OSAMU-Retainer®

1.0 x 125 mm, square	3270.1 10 pieces	3270.2 100 pieces
1.5 x 125 mm	3183.1 10 pieces	3183.2 100 pieces
2.0 x 125 mm	3185.1 10 pieces	3185.2 100 pieces
3.0 x 125 mm	3187.1 10 pieces	3187.2 100 pieces
4.0 x 125 mm	3188.1 10 pieces	3188.2 100 pieces
5.0 x 125 mm	3374.1 10 pieces	

CE 0044



## BIOPLAST® bleach

Soft pliable rubber like material, specifically destined for fabrication of bleaching splints. Material does not bond to acrylic. Hardness Shore A: 92.

1.0 x 125 mm

3190.1  
10 pieces

3190.2  
100 pieces

CE

## BIOPLAST® Color

Soft, pliable rubber like material, does not bond to acrylic. Hardness Shore A: 85.

### Application

Coloured sports mouth guards, positioners

Color-Set	3271.1 10 pieces
3.0 x 125 mm, red	3282.1 10 pieces
3.0 x 125 mm, neon red	3352.1 10 pieces
3.0 x 125 mm, neon green	3353.1 10 pieces
3.0 x 125 mm, azure	3354.1 10 pieces
3.0 x 125 mm, red-transparent	3355.1 10 pieces
3.0 x 125 mm, blue-transparent	3356.1 10 pieces
3.0 x 125 mm, white	3445.1 10 pieces
3.0 x 125 mm, black	3448.1 10 pieces



CE

## BIOPLAST® Multicolor

Soft, pliable rubber like material, does not bond to acrylic.  
Hardness Shore A: 85.

### Application

Coloured sports mouth guards, positioners

// 3.0 x 125 mm, Germany	<b>3390.1</b> 10 pieces
// 3.0 x 125 mm, France	<b>3391.1</b> 10 pieces
// 3.0 x 125 mm, Italy	<b>3392.1</b> 10 pieces
// 3.0 x 125 mm, Spain	<b>3393.1</b> 10 pieces
// 3.0 x 125 mm, Sweden	<b>3394.1</b> 10 pieces
// 3.0 x 125 mm, Brazil	<b>3395.1</b> 10 pieces
// 3.0 x 125 mm, Transylvania	<b>3396.1</b> 10 pieces
// 3.0 x 125 mm, Atlantis	<b>3397.1</b> 10 pieces
// 3.0 x 125 mm, White Dots	<b>3398.1</b> 10 pieces
// 3.0 x 125 mm, Green Dots	<b>3399.1</b> 10 pieces
// 3.0 x 125 mm, Multicolor Set	<b>3400.1</b> 10 pieces

CE



## BIOPLAST® XTREME

BIOPLAST® XTREME material is ideally suited for simple and safe preparation of individual sports mouth guards. Hard V-shaped reinforcement layer (Shore A: 92) ensures additional protection in the anterior region, allowing precise positioning in the desired extension. Soft layer (Shore A: 85) can be used for lamination with BIOPLAST® or for insertion of the counter bite.

Only for MINISTAR® from 4/92 and BIOSTAR® from 4/99.

// 4.0 x 125 mm, red	<b>3295.1</b> 10 pieces
// 4.0 x 125 mm, blue	<b>3296.1</b> 10 pieces
// 4.0 x 125 mm, black	<b>3297.1</b> 10 pieces
// 4.0 x 125 mm, clear	<b>3298.1</b> 10 pieces
// 5.0 x 125 mm, red	<b>3286.1</b> 10 pieces
// 5.0 x 125 mm, blue	<b>3287.1</b> 10 pieces
// 5.0 x 125 mm, black	<b>3288.1</b> 10 pieces
// BIOPLAST® XTREME, 5.0 x 125 mm, clear	<b>3289.1</b> 10 pieces

CE



## BIOPLAST® XTREME Kit

Two different degrees of hardness in one pressure moulding blank thanks to the integrated reinforcement in the delicate anterior region. Absorbs hard and flat impacts in contact sports. V-shaped harder insert (Shore A: 92) for variable size of front tooth protection.

Kits come with 1 BIOPLAST® XTREME 5.0 x 125 mm, 1 bag of 15 g CETRON® cleaning powder, 1 BIOPLAST® insulating agent, retainer box.

Only for MINISTAR® from 4/92 and BIOSTAR® from 4/99.

// red	3283.1 1 kit
// blue	3284.1 1 kit
// black	3285.1 1 kit

CE



## BIOPLAST® XTREME PRO Kit

For professional sports where hard and flat impacts often occur. Additional hard-elastic insert for integrated reinforcement in the anterior region.

Kits come with 1 BIOPLAST® XTREME 4.0 x 125 mm, 1 BIOPLAST® clear 2.0 x 125 mm, 1 DURAN® 0.75 x 125 mm, 1 bag of 15 g CETRON® cleaning powder, 1 BIOPLAST® insulating agent, retainer box.

Only for MINISTAR® from 4/92 and BIOSTAR® from 4/99.

// red	3292.1 1 kit
// blue	3293.1 1 kit
// black	3294.1 1 kit

CE



## BRUX CHECKER® acc. to Prof. Sato

Foil with one-side colour coating for analysis and therapy planning in case of bruxism and CMD as well as for control and grinding of prosthetic restorations.

// 0.1 x 125 mm, red	3209.1 10 pieces
----------------------	---------------------

CE



## IMPRELON®

Hard material, not elastic, bonds to acrylic for fixing handles of impression trays (REF 3216). Not suitable for occlusal splints.

### Application

Material in clear and opaque for impression trays, material in white for bite registration.

// 2.0 x 125 mm, clear	<b>3164.1</b> 10 pieces	
// 3.0 x 125 mm, clear	<b>3168.1</b> 10 pieces	<b>3168.2</b> 100 pieces
// 3.0 x 125 mm, weiß	<b>3274.1</b> 10 pieces	
// 3.0 x 125 mm, opaque	<b>3361.1</b> 10 pieces	

CE



## IMPRELON® S pd

Extremely break and abrasion-resistant material. Already pre-dried and vacuum sealed for instant use. Not indicated for adjustments using acrylics.

### Application

OSAMU-Retainer®, miniplast splints, retention splints

// 0.5 x 125 mm, clear	<b>3320.1</b> 10 pieces	
// 0.75 x 125 mm, clear	<b>3322.1</b> 10 pieces	<b>3322.2</b> 100 pieces
// 1.0 x 125 mm, clear	<b>3324.1</b> 10 pieces	<b>3324.2</b> 100 pieces
// 1.5 x 125 mm, clear	<b>3326.1</b> 10 pieces	
// 2.0 x 125 mm, clear	<b>3328.1</b> 10 pieces	
// 3.0 x 125 mm, clear	<b>3330.1</b> 10 pieces	

CE 0044

## OSAMU-Retainer® Kit

Transparent retainer acc. to Dr. Yoshii. Pressure-moulded using BIOPLAST® 1.5 mm and IMPRELON® S pd 0.75 mm and OSAMU Bond for optimal compound of material. OSAMU-Retainer® Kit for fabrication of 10 retainers. All components also available separately.

// OSAMU-Retainer® Kit 10x IMPRELON® S pd (0.75 x 125 mm), 10x BIOPLAST® (1.5 x 125 mm), 10 ml OSAMU-bond	<b>3242.1</b> 1 kit
---	------------------------

CE



## COPYPLAST®

Tough-elastic material, does not bond to acrylic, opaque.

### Application

Duplication moulds for situation models made of acrylics, bleaching splints, bracket transfer masks, moulds for temporary crowns and bridges, space holders.

// 0.5 x 125 mm	3177.1 10 pieces	3177.2 100 pieces
// 0.75 x 125 mm	3169.1 10 pieces	3169.2 100 pieces
// 1.0 x 125 mm	3179.1 10 pieces	3179.2 100 pieces
// 1.5 x 125 mm	3175.1 10 pieces	3175.2 100 pieces
// 2.0 x 125 mm	3181.1 10 pieces	3181.2 100 pieces

CE



## COPYPLAST® C

Transparent, tough-elastic and break- and abrasion-resistant material, does not bond to acrylic.

### Application

Long term splints and retainers, orthodontic splints

// 1.0 x 125 mm	3403.1 10 pieces	3403.2 100 pieces
-----------------	---------------------	----------------------

CE 0044

## HARDCAST®

Hard-elastic material, does not bond to acrylic, combustible leaving no residue, opaque.

### Application

Copings, spacer foil for bleaching splints

// 0.4 x 125 mm	3194.1 10 pieces
// 0.6 x 125 mm	3195.1 10 pieces
// 0.8 x 125 mm	3200.1 10 pieces

CE



## ISOFOLAN®

Foil ensures optimum insulation for plaster against resin in the pressure moulding technique. Best suited as insulation foil when pressurising hard-elastic material for splints.

0.1 x 125 mm

3207.1  
100 pieces



## Spacer foil

For use as a clear base foil, space maintainer and insulating foil for use with COPYPLAST® and HARDCAST® as well as for fabrication of copings from HARDCAST®. Remove before embedding the model.

0.1 x 125 mm

3202.1  
100 pieces



## Skin packaging

Protection packaging for sending out high quality models, consisting of cardboard and coating foil.

Skin packaging

3206.1  
100 pieces

## Coating foil

Protection cover for study and orthodontic models.

0.15 x 125 mm

3203.1  
100 pieces



## Sampler of pressure moulding material

Sampler of all available pressure moulding materials with indication of thickness, diameters and colours. Helpful information on working procedures and chemical and physical parameters is given as well.

// Sampler of pressure moulding material

3135.1  
1 piece



## Resins, auxiliaries and accessories

### BLUE-BLOKKER®

Light-curing, blue-transparent blocking-out and modelling putty with optimum flow properties. For fabrication of space holders for bleaching splints and medical trays as well as for sealing and blocking set-up models. Burns without leaving any residue, can therefore also be used in prosthetics for the fabrication of fixed and removable dentures. Telescopic models are stable and can be lifted without tension. Curing in the wavelength range of 380 - 470 nm.

4 x 1.5 g  
incl. 2 cannula Ø 0.6 mm and 8 cannula Ø 0.9 mm

5276.1  
1 piece



### CLEAR-BLOKKER®

Light-curing, high-transparent gel for adjustments on pressure moulded DURAN® splints, reinforced with DURASPLINT® LC. Gel is best suited for removal of air inclusions and insertion of canine guidance. Polymerisation in wavelength range 360–420 nm, for example using LC-6 Light Oven. Prior to processing, LC primer has to be applied to DURAN® splints.

4 x 1.5 g  
incl. 2 cannula Ø 0.4 mm and 8 cannula Ø 0.9 mm

5261.1  
1 piece

CE



### Cannula

For use with BLUE-BLOKKER® and CLEAR-BLOKKER.

Ø 0.4 mm

5277.1  
5 pieces

Ø 0.9 mm

5278.1  
5 pieces



### SIL-KITT

Permanently plastic silicone, used specifically for blocking-out undercuts when fabricating pressure moulded splints, anti-snoring and orthodontic appliances.

red

3442.1  
150 g

transparent

3443.1  
150 g



## Blocking-out putty

Permanently plastic putty for blocking-out large-scale undercuts.

// Blocking-out putty	<b>3220.1</b> 250 g
-----------------------	------------------------



## BIOPLAST® Insulating agent

Insulation for plaster models when using BIOPLAST® material in the fabrication of positioners and sports mouthguard. BIOPLAST® insulating agent provides absolute transparency and smooth inner surfaces. Also available in practical 100 ml applicator bottle for quick and non-drip insulation of plaster models.

// BIOPLAST® Insulating agent applicator bottle with 3 tips	<b>3166.1</b> 100 ml
// BIOPLAST® Insulating agent	<b>3189.1</b> 500 ml



## BIOCRYL® Resin

Special orthodontic acrylic for attaching clasp arms and relining expansion screws when producing retention and expansion plates with BIOCRYL® C in the thermoforming technique. Material polymerises during the cooling phase in the pressure moulding unit. Time-consuming polymerisation in pressure polymerisation unit is not required.

// monomer	<b>3218.1</b> 0.25 l	<b>3218.2</b> 0.5 l
// polymer	<b>3221.1</b> 400 g	<b>3221.2</b> 1 kg

CE 0044



## DURASPLINT®

High-transparent cold-cure resin specifically designed for fabricating occlusal splints with adjusted occlusion. Very simple to use, little shrinkage, optimised trimming.

// kit incl. 200 g polymer and 100 ml monomer, mixing and dosing cup, 20ml orthodontic insulating agent incl. brush, pipette, glass spatula and detailed instructions	<b>3257.1</b> 1 kit	
// polymer	<b>3258.1</b> 200 g	<b>3258.2</b> 400 g
// monomer	<b>3259.1</b> 100 ml	<b>3259.2</b> 0.25 l

CE 0044





## DURASPLINT® flex

The MMA-free, self-curing splint material DURASPLINT® flex with thermoplastic memory effect for use in casting and pressing techniques. The material is flexible at body temperature, leading to an increased wearing comfort. At the same time, the material is characterized by a high restoring torque at room temperature, high breaking resistance, durability and permanent transparency. Available as kit for fabrication of approx. 17-18 splints, also as milling blank in thicknesses of 16 and 20 mm.



// kit	incl. 180 g polymer and 130 g monomer, mixing and dosing cup, pipette, glass spatula and detailed instructions	<b>3610.1</b> 1 kit
// polymer		<b>3611.1</b> 180 g
// monomer		<b>3612.1</b> 130 g

CE 0044



## DURASPLINT® LC

Light-curing, transparent resin, specifically designed for the adjustment of DURAN® splints with a minimal thickness of 1.5 mm. Does not require curing in pressure polymerisation unit. For polymerisation, we recommend using the LC 6 light oven with pre-set polymerisation times of 5 or 10 min. Curing in the wavelength of 350 – 450 nm. Prior to processing, LC primer has to be applied to DURAN® splints.

No yellow discolouration of material after light-curing.

// kit	3 bars (38 g in total) DURASPLINT® LC, 1.5 g CLEAR BLOKKER® with 2 cannula, 10 ml LC primer with brush, 10g LC insulation, 1 LC bur A, B and C each, 1 SD polishing paste A and B each, 5 SD polishing brushes, SD felt discs and SD high-gloss polishing mops with mandrel	<b>3256.1</b> 1 kit
--------	---	------------------------

// 3 bars, 38 g	W x L x H: 32 x 120 x 8 mm	<b>3261.1</b> 1 piece
-----------------	----------------------------	--------------------------

CE



## LC Primer

Light-curing primer for pre-treating DURAN® splints before adjusting them with DURASPLINT® LC or CLEAR BLOKKER®. For polymerisation, we recommend using the LC 6 Light Oven with pre-set polymerisation times of 5 or 10 min. Curing in the wavelength of 350 – 450 nm.

LC Primer  
with brush

3263.1  
10 ml

CE



## LC Insulation

Facilitates modelling DURASPLINT® LC on DURAN® splints. Ensures clean and neat working results with smooth surfaces, considerably simplifying finishing.

LC Insulation

3266.1  
10 g



## OSAMU-Bond

Bonding agent for optimum compound of BIOPLAST® and IMPRELON® S pd in the pressure moulding technique.

OSAMU-Bond

3246.1  
10 ml

CE



## Impression tray handles

Stable, handy plastic handles which can be fixed to tray with cold cure resin and individually formed by heating.

Impression tray handles

3216.1      3216.2  
10 pieces      100 pieces

CE



## Foam discs

Foam discs can be used as space holder and insulation for pressure moulded impression trays, providing retention to impression material.

Foam discs

3444.1  
10 pieces



## Stainless steel pellets

Stainless steel pellets, highly polished by galvanic treatment, for embedding models in pressure moulding machines. Thanks to the cylindrical pellet shape, models are securely positioned and cannot be pressed into the pellets.

// Stainless steel pellets

**3222.1**  
1 kg



## Pellet cover

Used for covering stainless steel pellets while thermoforming splints. Cover is reusable and avoids adhesion of pellets to the heated soft material.

// large

**3006.1**  
5 pieces

// small

**3007.1**  
5 pieces



## Pellet brush

Pellet brush with integrated magnet for quick removal of pellets and for easy lifting the model platform from the model cup.

// Pellet brush

**3136.1**  
1 piece



## Model platform 85 mm

Model platform with 85 mm diameter provides increased surface for dental arch models made of resin and hard plaster, preventing the model from getting pressed into the stainless steel pellets.

// Model platform, Ø 85 mm

**3134.1**  
1 piece



## Heating support

Can be attached directly to the heater when fabricating positioners and sports mouthguard, providing the optimum distance between model and heater when heating the occlusal surfaces and for compound of upper and lower splint. For BIOSTAR® and MINISTAR S®.

Dimensions (W x H x D): 190 x 160 x 70 mm

// Heating support

**3452.1**  
1 piece



## Finishing and polishing

Learn more:



### SD-Foil scissors A

SD foil scissors A are delicately made of a high-grade auto-clavable stainless steel alloy. For better handling, scissors are laterally curved. Micro serration prevents slipping.

// SD-Foil scissors A

3460.1  
1 piece



### SD-Foil scissors B

SD foil scissors B are robust and durable for cutting splints or inserting cuts into splints after thermoforming.

// SD-Foil scissors B

3461.1  
1 piece



### Finishing set

Set containing eight grinding instruments for cutting, trimming and finishing of soft-elastic and hard-elastic material. With color coding for easy identification.

// Finishing set

Set comes with one each cutting bur, finishing bur, HM carbide bur, HM tricutter fine, BIOPERM trimmer, POLYFIX, OSAMU polisher, DIMO®PRO SLIM and dressing stone.

3378.1  
1 piece

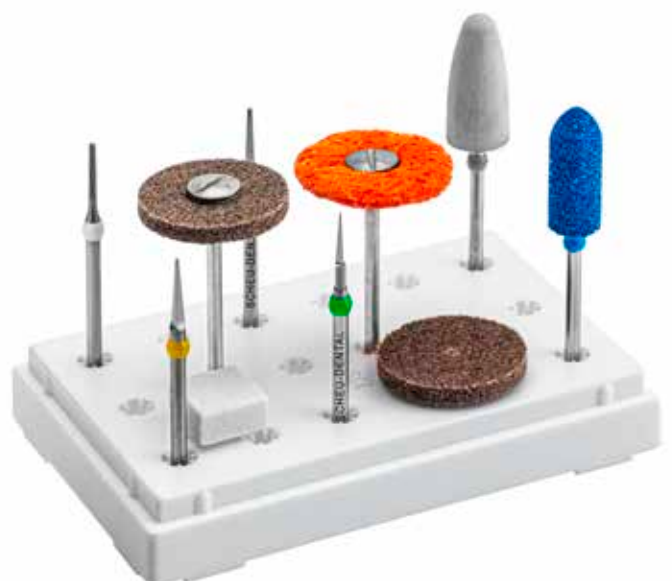

## LC-Bur

Specifically designed for finishing cold cure resin or light cured adjustments on splints. Allows neat cutting without clogging and leaving any residue. LC bur A comes in conical form for specific finishing or occlusal grinding. LC bur B is pear-shaped, ensuring very smooth grinding surface patterns when it comes to larger surfaces and LC bur C comes in bud form for quick and uniform removal of roughness.



## Finishing bur

Square cutting bur made of special soft alloy that does not damage clasp wires.



## HM-Tricutter fine

Fine triangular bur for interdental finishing of splints.



## HM-Carbide cutter

Triangular carbide cutting bur for quick, neat cutting of hard pressure moulding material.



## Cutting bur

Spiral cutting bur for quick, neat cutting of hard pressure moulding material.



LC-Bur A maximum rotational speed: 20,000 r/min	3267.1 1 piece
LC-Bur B maximum rotational speed: 20,000 r/min	3268.1 1 piece
LC-Bur C maximum rotational speed: 20,000 r/min	3265.1 1 piece
Finishing bur (red) maximum rotational speed: 7,500 r/min	3377.1 6 pieces
HM-Tricutter fine (green) maximum rotational speed: 7,500 r/min	3370.1 6 pieces
HM-Carbide cutter (yellow) maximum rotational speed: 7,500 r/min	3369.1 6 pieces
Cutting bur maximum rotational speed: 25,000 r/min	3214.1 6 pieces

## OSAMU Polisher

Finishing and polishing of soft-elastic and compound material.

## POLYFIX

For trimming and final polishing of soft-elastic and compound material, brown. The discs should be shaped before use with a sharpening stone.

## BIOPERM Trimmer

For grinding and finishing soft-elastic and sandwich material, blue.



// OSAMU Polisher, grey maximum rotational speed: 15,000 r/min	<b>3247.1</b> 2 pieces
// POLYFIX, on mandrel maximum rotational speed: 12,000 r/min	<b>3371.1</b> 1 piece
// POLYFIX, discs maximum rotational speed: 12,000 r/min	<b>3372.1</b> 6 pieces
// BIOPERM Trimmer, blue maximum rotational speed: 25,000 r/min	<b>3226.1</b> 2 pieces



## DIMO® PRO / DIMO® PRO SLIM

Trimming wheel made of special elastomer with fine fibrous structure, extremely long working time, incl. mandrel. The discs should be shaped before use with a sharpening stone.

### Application DIMO®PRO

For finishing large-scale marginal areas and for final and high-gloss polishing of splints, positioners, sports mouthguard and orthodontic appliances. Provides highly-polished rims and uniform surfaces of hard/soft compound material.

### Application DIMO®PRO SLIM

For finishing splints, specifically in the area of ligaments and interdental spaces.

// DIMO®PRO, Ø 24 x 6 mm, incl. 1 mandrel maximum rotational speed: 10,000 r/min	<b>3381.1</b> 10 pieces	<b>3381.2</b> 50 pieces
// DIMO®PRO SLIM, Ø 24 x 4 mm, incl. 1 mandrel maximum rotational speed: 10,000 r/min	<b>3376.1</b> 10 pieces	<b>3376.2</b> 50 pieces

## DIMO®

Stable and flexible trimming wheels with prolonged processing time, three types of grains, incl. mandrel.

### Application

Trimming and initial polishing of elastomer, sandwich material, sports mouthguard and orthodontic appliances.

// brown / coarse, incl. 1 mandrel maximum rotational speed: 10,000 r/min	<b>3382.1</b> 10 pieces	<b>3382.2</b> 50 pieces
// green / medium, incl. 1 mandrel maximum rotational speed: 10,000 r/min	<b>3383.1</b> 10 pieces	<b>3383.2</b> 50 pieces
// maroon / fine, incl. 1 mandrel maximum rotational speed: 10,000 r/min	<b>3384.1</b> 10 pieces	<b>3384.2</b> 50 pieces
// mandrel	<b>3380.1</b> 10 pieces	



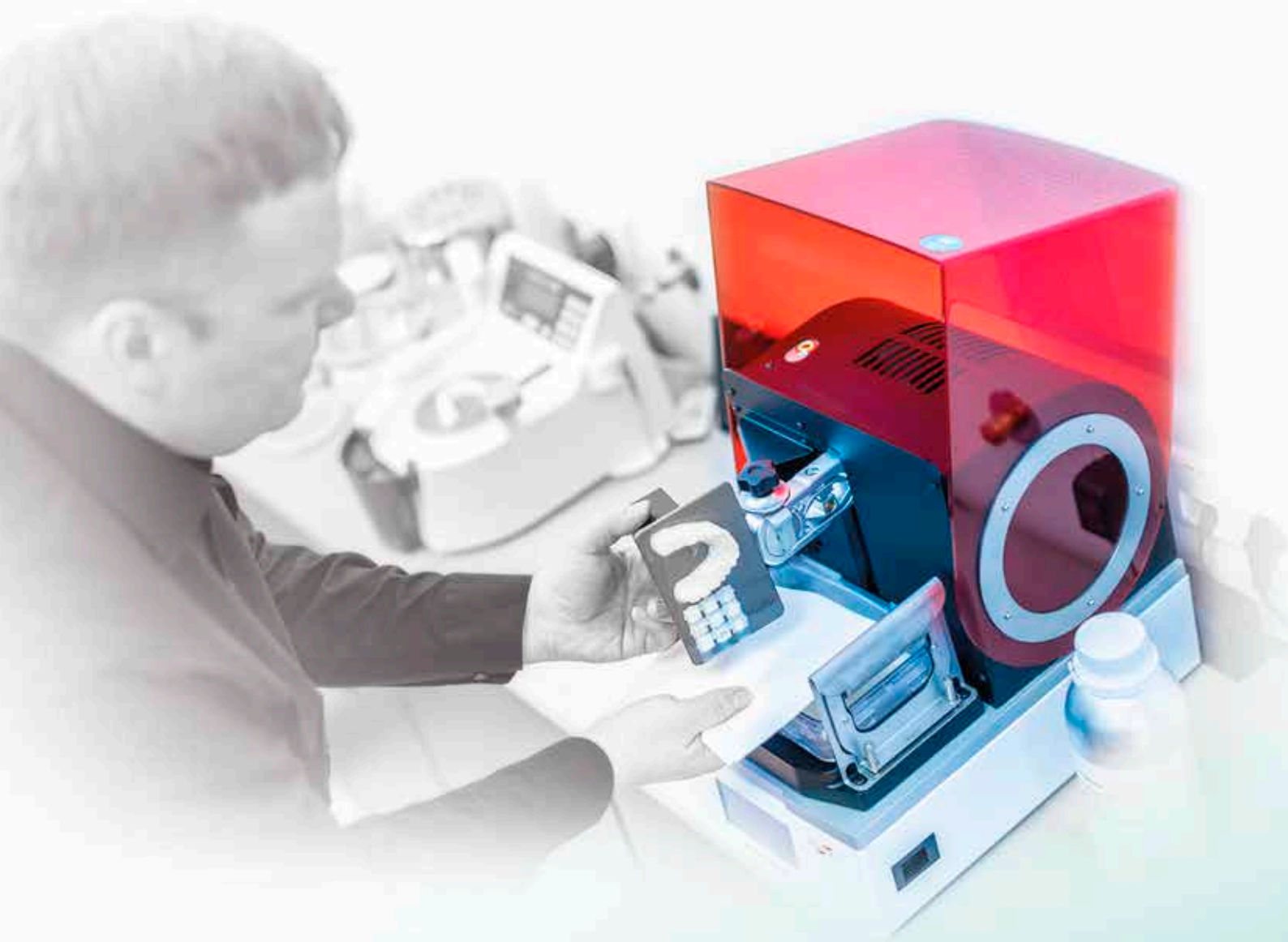



# Laboratory equipment

We are setting benchmarks!

**We are setting benchmarks, instead of just meeting standards.**  
 From O-ring to the microprocessor control – our specialists in the equipment manufacturing are well versed. All parts are manufac-

tured with maximum precision and attention to detail, which is why our pressure moulding units are delivered with a three-year warranty.

3D Printing .....	112	Pressure moulding technique.....	116
Light curing .....	115	Auxiliaries.....	118

## 3D Printing

### Asiga MAX™

With DLP technology and maximum ease of use, the Asiga MAX™ printer allows for fast, precise and efficient operation. The built-in LCD panel with touch function displays the information on the current construction process and allows interactive control of the printer. The light sensor provides consistent projector performance and uniform resin curing, the smart positioning system (SPS™) ensures precise printing results. Print jobs can be stored in a queue, started from the control panel and transmitted via Ethernet or WiFi. The printer can also operate as a wireless hot spot.

#### Technical data

Build volume (X, Y, Z): 119 x 67 x 76 mm  
 Pixel size: 62 µm  
 Image technology: DLP  
 Light source: UV LED projector with HD chip  
 Wave length: 385 nm  
 Voltage: 100 - 240 V, 50/60 Hz  
 Power: 500 W  
 Consistent data formats: STL, SLC, STM  
 Dimensions (w x d x h): 260 x 380 x 370 mm

// Asiga MAX™

6501.1  
1 piece



**New**

### Tray Box Asiga MAX™

Plastic box made of opaque material for storing filled trays of the Asiga MAX™ printer. The printer resin can remain in the trays during storage as it does not harden inside the opaque box. With write-on lid allowing simultaneous storing of several boxes.

// Tray Box Asiga MAX™

6552.1  
1 piece

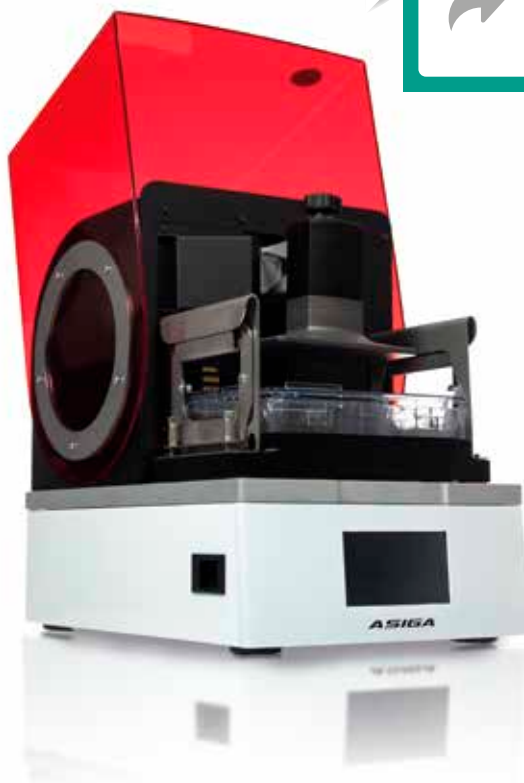

Learn more:



### Asiga MAX™ Tray

The tray system of the Asiga MAX™ allows for easy changing and refilling of materials. Four trays with maximum print capacity of 1l, 2l, 5l or 10l and a maximum fill level of 300 to 400 ml per application are available. Equipped with RFID chip for recording the object volume generated during the print job. It is not possible to use the tray exceeding the maximum print volume.

// 2l	6515.1 1 piece
// 1l	6516.1 1 piece
// 5l	6517.1 1 piece
// 10l	6518.1 1 piece







## Asiga PRO 4K

Asiga PRO 4K is a floor-standing 3D printer utilizing the latest DLP imaging technology and combining precision, reliability and speed for high print volumes in the most demanding production applications. Equipped with 4K mode to reduce pixel size, the Asiga PRO 4K can print up to 21 dental arches per print job within one hour and a maximum of 54 dental arches in three layers within less than four hours. In addition to the proven SPST™ sensor-based positioning system, the anti-aliasing system for automatic edge smoothing and the multirange tool for optimising print time, the Asiga PRO 4K offers the usual user-friendly features such as Asiga Composer software, touchscreen display, easy user interface, WiFi and remote control via web interface..

Asiga PRO 4K is available in two versions that differ in pixel resolution (65 or 80 µm) and thus build volume.

### Technical data

Build space (X, Y, Z): 177 x 99 x 200 mm (Asiga PRO 4K65) /  
217 x 122 x 200 mm (Asiga PRO 4K80)  
Pixel size: 65 µm without/46 µm with 4K mode for Asiga PRO 4K65  
80 µm without/56 µm with 4K mode for Asiga PRO 4K80  
Layer thickness: continuously adjustable from 25 -150 µm  
Image technology: DLP  
Light source: high power UV LED projector with 4K chip  
Wavelength: 385 nm  
Voltage source: 100 - 240 V, 50/60 Hz  
Power: 600 W  
File input: STL, SLC, STM  
Dimensions (d x w x h): 475 x 540 x 1,375 mm  
Weight: 140 kg

/// Asiga PRO 4K65	<b>6538.1</b> 1 piece
/// Asiga PRO 4K80	<b>6539.1</b> 1 piece

## Asiga PRO Tray

The tray system of the Asiga PRO 4K printers ensures easy changing and refilling of materials. It includes three different trays with a maximum print capacity of 2l, 5l or 10l. With RFID chip for recording the object volume generated during the printing process. It is not possible to use the tray beyond its maximum print volume.

/// 2l	<b>6521.1</b> 1 piece
/// 5l	<b>6523.1</b> 1 piece
/// 10l	<b>6524.1</b> 1 piece



**New**

## RS wash

The fully automated cleaning device makes cleaning your 3D printed parts safe and easy by removing sticky residues in a pre- and post cleaning process with final drying that takes approximately 6 - 8 minutes. For a perfect finish, the consumption of the cleaning liquid is optimized to a minimum level without affecting the cleaning quality.

### Technical data

Voltage: 24 V

Power: 120 W

Dimensions: 230 x 270 x 450 mm

Cleaning chamber: 130 x 75 x 60 mm

(800 ml capacity cleaning cartridges)

Network compatibility: WLAN/LAN

Touch panel: 5.8"



// RS wash

**6536.1**  
1 piece

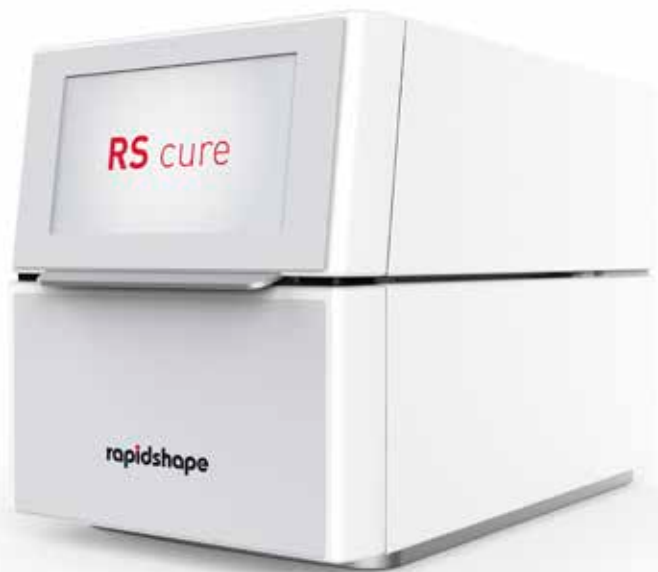

**New**

## RS cure

Light curing unit for the polymerisation of 3D-printed parts in only 4-12 minutes. The powerful LEDs used in the exposure system ensure 360° homogeneous curing in the UVA and UVB range in combination with either vacuum or inert gas.

### Technical data

Voltage: 24 V

Power: 220 W

Dimensions: 230 x 270 x 380 mm

UV chamber: 130 x 75 x 60 mm

Network compatibility: WLAN/LAN

Touch panel: 5.8"

// RS cure

**6535.1**  
1 piece

## Light curing

Learn more:



### LC-6 Light Oven

High-capacity light polymerisation unit for up to 4 models and fixator. Its inner dimensions of 170 x 160 x 120 mm (W x D x H) offer enough space for articulated and mounted models. Six fluorescent light tubes (3 UVA and 3 blue light tubes) and an aluminium reflector guarantee homogeneous illumination. Two polymerisation times of 5 and 10 minutes are already pre-set in accordance with the light-curing DURASPLINT® LC material. Continuous operation can also be set. Spectral range of the light curing device between 350 and 450 nm. Auto start function for easier application.

#### Technical data

Voltage: 230/115 V

Dimensions (W x H x D): 240 x 180 x 270 mm

Weight: 3 kgs

3 years warranty, 10 years warranty on availability of spare parts

// 230 V

5610.1  
1 piece

// 115 V

5620.1  
1 piece

# Pressure moulding technique

Learn more:



## BIOSTAR®

Versatile pressure moulding machine for all applications in dental pressure moulding and orthodontics, equipped with scan technology and 6.0 bar working pressure, adjustable by pressure reducing valve on the unit. The unique thermally controlled infrared heater reaches working temperature in one second. All parameters such as temperature, heating and cooling times are programmed by reading the scanner or entering the corresponding code. The coloured 3.2" LCD display with a resolution of 320 x 240 pixel leads you through the single working steps of the pressure moulding process, providing further information on scanned material, its indication as well as a library with illustrated application hints and videos for fabrication. The BIOSTAR® ensures accurate thermoforming results using material thicknesses up to 5 mm. Thanks to the high pressure chamber, bimaxillary appliances can also be fabricated. The large model pot facilitates embedding of mounted models and the generously dimensioned drawer guarantees optimal dosing and storage of the granulate. With interface for easy updates.

### Technical data

Voltage / power: 230/115/100 V, 750 W  
 Working pressure: 0.5 - 6.0 bar  
 Dimensions: (W x H x D): 520 x 240 x 440 mm  
 Weight: 14 kgs  
 3 years warranty, 10 years warranty on availability of spare parts

/// 230 V	3001.1 1 piece
/// 115 V	3011.1 1 piece
/// 100 V	3021.1 1 piece

## BIOSTAR® Protection cover

Made of transparent plastic, avoids soiling.

/// BIOSTAR® Protection cover

3449.1  
1 piece





## MINISTAR S®

The compact pressure moulding unit MINISTAR S® equipped with scanning technology: scanner reads the coded material, allowing programming of all important parameters such as heating time, temperature and cooling time. Precise pressure moulding results are reached in record time thanks to the extremely fast, patented heater and working pressure of 4.0 bar, adjustable via pressure regulator. Equipped with user-friendly membrane keypad and large display which indicates and monitors all operating parameters.

### Technical data

Voltage / power: 230/115/100 V, 750 W

Working pressure: 0.5 - 4.0 bar

Dimensions (W x H x D): 500 x 210 x 400 mm

Weight: 9 kgs

3 years warranty, 10 years availability of spare parts

/// 230 V	3501.1 1 piece
/// 115 V	3511.1 1 piece
/// 100 V	3521.1 1 piece

## MINISTAR S® Protection cover

Made of transparent plastic, avoids soiling.

/// MINISTAR S® Protection cover

3447.1  
1 piece



## Auxiliaries

### Model holder

With flexible clamps and movable joints, keeps small and large models fixed in any required position.

// Model holder

5270.1  
1 piece



### Parallelometer

Indispensable auxiliary instrument when fabricating precise adjusted splints. The parallelometer enables determination of insertion direction and marking of tooth equator. The extensions of DURAN® splints, built-up with DURASPLINT® LC, should not exceed the tooth equator to avoid cracks or fissures when inserting or removing the splint.

Includes measurement accessories:

Guiding pin

Wax scraper

Cone

Measurement instrument (0.25 mm diameter)

Measurement instrument (0.50 mm diameter)

Measurement instrument (0.75 mm diameter)

// Parallelometer  
incl. model holder, graphite leads and measurement accessories

5362.1  
1 piece

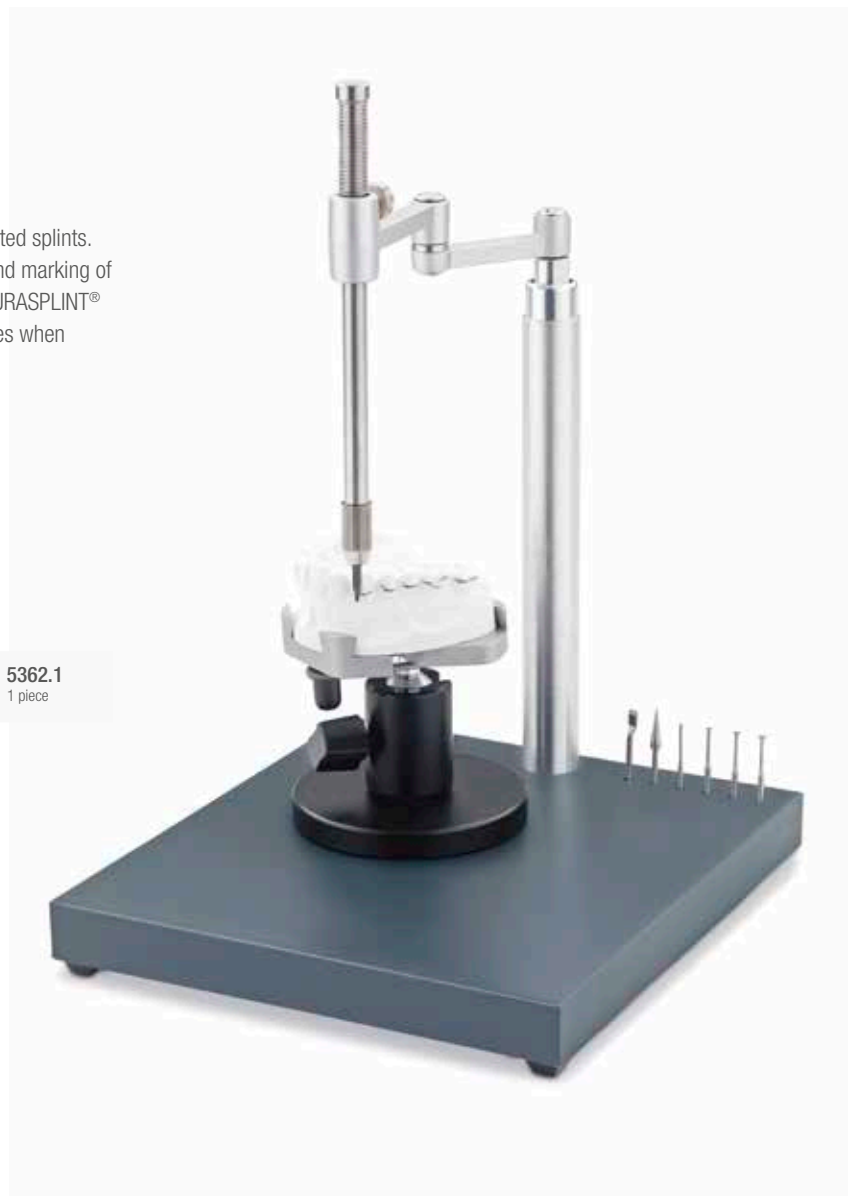

## Split-Fixator

Stable occlusal holder with sliding arms. By unscrewing the centring tips, models can be removed without any damage and reinserted at any time in exactly the same position. Precise dovetailed guidance avoids twisting of fixator arms.

// Split-Fixator

5380.1  
1 piece



## Hinge fixator

Thanks to the hinge in the upper part of the fixator, grinding of functional orthodontic appliances and fabrication of bimaxillary appliances becomes easier. Mounting splints on fixator arms ensure easy removal and precise repositioning of models.

// Hinge fixator

5374.1  
1 piece

// peaked screws

5376.1  
10 pieces



## Mounting rails

Suitable for hinge fixator.

// Mounting rails

5375.1  
10 pieces



## Indication Chart on Applications in the Pressure Moulding Technique

Indication	Product	Recommended Thickness
Anti-snoring splint	DURAN®	2.0 mm
	DURAN®+	2.0 mm
	DURASOFT® pd with DURASOFT® seal	1.8 / 2.5 mm
Bite taking / Bite registration	IMPRELON® white, clear	2.0 / 3.0 mm
Bleaching splint	BIOPLAST® bleach	1.0 mm
	COPYPLAST®	1.0 mm
Bracket transfer mask	COPYPLAST®	0.5 / 0.75 mm
Copings	HARDCAST®	0.4 / 0.6 / 0.8 mm
Cosmetic splint	DURAN®+ A2	0.5 - 0.75 mm
	DURAN®+ white pd	0.5 - 1.0 mm
Etching mask	COPYPLAST®	1.0 mm
Fluorisation splint	DURAN®	1.0 / 1.5 mm
	DURAN®+	1.0 / 1.5 mm
Foil for therapy planning / analysis of bruxism	BRUX CHECKER®	0.1 mm
Immediate Dentures / temporary dentures	BIOCRYL® C (rose or clear)	2.0 / 3.0 mm
Individual impression tray, functional tray	IMPRELON® (clear)	2.0 / 3.0 mm
	IMPRELON® (opaque)	3.0 mm
Insulation Foil	ISOFOLAN®	0.1 mm
Invisible Retainer / Orthodontic splint	DURASOFT® pd with DURASOFT® seal	1.2 mm
	DURAN®	0.4 - 1.0 mm
	DURAN®+	0.4 - 1.0 mm
	IMPRELON®S pd	0.5 - 1.0 mm
	COPYPLAST® C	1.0 mm
Medical tray	DURAN®	1.0 mm
	DURAN®+	1.0 mm
Model duplication	BIOPLAST® (plaster)	min. 3.0 mm
	COPYPLAST® (resin)	2.0 mm
Model protection / Protective coating / Skin-packaging	Coating Foil	0.15 mm
Moulds for temporary crowns and bridges	COPYPLAST®	0.5 - 2.0 mm
Mouth Guard, sports protection	BIOPLAST®	1.0 - 5.0 mm
	BIOPLAST® XTREME / XTREME PRO	4.0 / 5.0 mm
Occlusal splint / Bruxism splint / Miniplast splint	DURAN®	1.0 - 1.5 mm
	DURAN®+	1.0 - 1.5 mm
	DURASOFT® pd optional with DURASOFT® seal	1.8 mm
OSAMU-Retainer® (combination BIOPLAST® and IMPRELON®S pd)	BIOPLAST®	1.5 mm
	IMPRELON®S pd with OSAMU-Bond	0.75 mm
Positioner	BIOPLAST®	2.0 - 5.0 mm
Retainer / Orthodontic plates	BIOCRYL® C	2.0 / 3.0 mm for lower jaw
Radiopaque splints	BIOCRYL® Form X	1.5 mm
Retention splint / Long-term retainer	CA® Retentionsfolie pd	0.75 / 1.0 mm
	COPYPLAST® C	1.0 mm
	DURAN®	0.75 / 1.0 mm
	DURAN®+	0.75 / 1.0 mm
Spacer maintainer foil for copings	Spacer foil	0.1 mm
	HARDCAST®	0.4 / 0.6 / 0.8 mm
Template for implants / Drillings / X-ray	DURAN®	2.0 / 3.0 mm
	DURAN®+	2.0 mm
Temporary Splint / Strip crown for temporary crowns and bridges	DURAN®	0.5 - 1.0 mm
	DURAN® +A2 pd	0.5 - 0.75 mm



Material Qualities	Bonds to Acrylic	Recommended Acrylic	Recommended Insulation
hard-elastic	yes	DURASPLINT®/ DURASPLINT® LC	ISOFOLAN® foil
hard-elastic	yes	DURASPLINT®/ DURASPLINT® LC	
hard / soft	yes	DURASPLINT®	ISOFOLAN® foil
hard / not elastic	yes	DURASPLINT®	ISOFOLAN® foil
soft-elastic	no		BIOPLAST® Insulating agent / soak model into water *
viscoplastic	no		Soak model shortly into water or spacer maintainer foil*
viscoplastic	no		Soak model shortly into water or spacer maintainer foil
viscoplastic	no		Spacer foil
hard-elastic	yes	veneering material	
hard-elastic	yes	veneering material	
viscoplastic	no		Soak model shortly into water or spacer foil
hard-elastic	yes		BIOPLAST® (space maintainer)
hard-elastic	yes		BIOPLAST® (space maintainer)
impact-resistant	yes	BIOCRYL® RESIN	ISOFOLAN® foil
hard / not elastic	yes	DURASPLINT®	ISOFOLAN® foil or Foam Discs
hard / not elastic	yes	DURASPLINT®	ISOFOLAN® foil or Foam Discs
viscoplastic insulation foil	no		
hard / soft	yes	DURASPLINT®/ DURASPLINT® LC	ISOFOLAN® foil
hard-elastic	yes	DURASPLINT®/ DURASPLINT® LC	ISOFOLAN® foil
hard-elastic	yes	DURASPLINT®/ DURASPLINT® LC	
hard-elastic / impact-resistant	not recommended		ISOFOLAN® foil
viscoplastic	no		Soak model shortly into water or spacer foil
hard-elastic	yes	DURASPLINT®/ DURASPLINT® LC	ISOFOLAN® foil
hard-elastic	yes	DURASPLINT®/ DURASPLINT® LC	
soft-elastic	no		BIOPLAST® Insulating agent / soak model into water
viscoplastic	no		Soak model shortly into water or spacer foil
bonds to Skin cardboard			
viscoplastic	no		Soak model shortly into water or spacer foil
soft-elastic	no		BIOPLAST® insulating agent
soft-elastic	no		BIOPLAST® insulating agent
hard-elastic	yes	DURASPLINT® / DURASPLINT® LC	ISOFOLAN® foil
hard-elastic	yes	DURASPLINT® / DURASPLINT® LC	
hard / soft	yes	DURASPLINT®	ISOFOLAN® foil
soft-elastic	no		BIOPLAST® insulating agent
hard-elastic / impact-resistant	no		
soft-elastic	no		BIOPLAST® insulating agent
impact-resistant	yes	BIOCRYL® RESIN	ISOFOLAN® foil
viscoplastic	no		Spacer maintainer foil
hard-elastic	no		ISOFOLAN® foil
viscoplastic	no		Soak model shortly into water or spacer foil
hard-elastic	yes	DURASPLINT®/ DURASPLINT® LC	ISOFOLAN® foil
hard-elastic	yes	DURASPLINT®/ DURASPLINT® LC	
hard-elastic / impact-resistant	not recommended		ISOFOLAN® foil
hard insulation foil	yes		
viscoplastic	no		Spacer foil
hard-elastic	yes	DURASPLINT®/ DURASPLINT® LC	ISOFOLAN® foil
hard-elastic	yes	DURASPLINT®/ DURASPLINT® LC	
hard-elastic	yes	veneering material	ISOFOLAN® foil
hard-elastic	yes	veneering material	

\* BLUE-BLOKKER as space maintainer/reservoir

## Technical properties of IMPRIMO® LC resins

Property	Standard	IMPRIMO® LC						
		Model	Splint	Splint flex	Impression	Cast		
<b>Colour</b>		ivory, grey, beige	transparent	transparent	orange	red		
<b>Density</b>		1.1 g/ml	1.1 g/ml	1.1 g/ml	1.1 g/ml	1.1 g/ml		
<b>Flexural strength</b>	ISO 178	108 MPa	93 MPa		84 MPa	86 MPa		
	ISO 10477							
	ISO 4049							
	ISO 20795-1							
	ISO 20795-2		64 MPa*	≥ 10 MPa				
<b>Tensile strength</b>	DIN 53504							
	DIN 53505							
<b>Elongation at break</b>	ISO 178	5.00 %	10.00 %		10.00 %	5.00 %		
	DIN 53505							
	DIN 53504			≥ 80 %				
<b>Flexural modulus</b>	ISO 20795-1							
<b>E-modulus</b>	ISO 178	2,327 MPa	2,121 MPa		1,776 MPa	1,791 MPa		
	ISO 20795-2		1,584 MPa*	≥ 250 MPa				
<b>Shore hardness</b>	ISO 7619-1	85D	80D	≥ 65	80D	85D		
<b>Viscosity (23°C)</b>	DIN 53019-1	0.7 Pa s	0.7 Pa s	< 1,5 Pa s	0.7 Pa s	0.3 Pa s		
<b>Solubility</b>	ISO 4049							
	ISO 20795-1							
	ISO 20795-2		1.4 µg mm-3	≤ 5 µg/mm <sup>3</sup>				
<b>Water absorption</b>	ISO 4049							
	ISO 20795-1							
	ISO 20795-2		24 µg mm-3	≤ 20 µg mm-3				
<b>Colour stability</b>	ISO 4049							
	ISO 10477							
<b>Biocompatibility: irritation and delayed-type allergies</b>	ISO 10993-10		comply	comply	comply			
<b>Biocompatibility: genotoxicity, carcinogenicity and toxicity for reproduction</b>	ISO 10993-3		comply	comply	comply			
<b>Biocompatibility: systemic toxicity</b>	ISO 10993-11		comply		comply			
<b>Biocompatibility: cytotoxicity</b>	ISO 10339-5		comply	comply	comply			
<b>Biocompatibility: hemocompatibility</b>	ISO 10993-4							

## Building material

	IMPRIMO® LC IBT	IMPRIMO® LC Gingiva	IMPRIMO® LC Temp	IMPRIMO® LC Temp It	IMPRIMO® LC MJF	IMPRIMO® LC Denture	IMPRIMO® LC Try-In
	transparent	rose	A1, A2, A3 (Vita classical)	A1, A2, A3 (Vita classical)	transparent	orange pink, light pink, deep pink	A1, A2, A3 (Vita classical)
	1.1 g/ml	1.1 g/ml	1.2 g/ml	1.4 g/ml	1.1 g/ml	1.1 g/ml	1.1 g/ml
			113 MPa	169 MPa	117 MPa	114 MPa	91 MPa
			91 MPa				
				112 MPa			
						84 MPa*	
					80 MPa		
	6.2 MPa						
		5 MPa					
			4,00%	4,00%	5,00%	8,00%	8,00%
		90.00 %					
	50.00 %						
						2,383 MPa*	
			2,442 MPa	5,528 MPa	2,508 MPa	2,438 MPa	2,028 MPa
					1,668 MPa		
	40D	50A	80D	80D	85D	85D	80D
	2.5 Pa s	2.5 Pa s	1.5 Pa s	3.5 Pa s	0.7 Pa s	0.5 Pa s	0.7 Pa s
			1.1 µg mm-3	1.1 µg mm-3			
						0.41 µg mm-3	
						0.51 µg mm-3	
			31.1 µg mm-3	31.1 µg mm-3			
						≤ 25.8 µg mm-3	
					19.9 µg mm-3		
			≤ 1.5	≤ 1.5			
						≤ 2.5	
	comply		comply	comply	comply	comply	comply
			comply	comply	comply	comply	comply
			comply	comply	comply	comply	comply
	comply		comply	comply	comply	comply	comply
					comply		

\* based on standard

## Indication chart for aligner material

Product	Recommended thickness	Material characteristics	Indication	Bonding with resin	Recommended resin	Recommended isolation/ miscellaneous
CA® Folie extra soft	0.4 mm	one-layer, hard-elastic	For extra-gentle/extremely gentle initial movement of teeth in the CA® CLEAR ALIGNER system	no		ISOFOLAN® Folie
CA® Folie soft	0.5 mm	one-layer, hard-elastic	For moving teeth in the CA® CLEAR ALIGNER system	no		ISOFOLAN® Folie
CA® Folie medium	0.625 mm	one-layer, hard-elastic	For moving teeth in the CA® CLEAR ALIGNER system	no		ISOFOLAN® Folie
CA® Folie hard	0.75 mm	one-layer, hard-elastic	For moving teeth in the CA® CLEAR ALIGNER system	yes	BIOCRYL®-RESIN	ISOFOLAN® Folie
CA® Pro	0.5/0.625/0.75	three-layer, hard-elastic	For moving teeth in the CA® CLEAR ALIGNER system.	no		ISOFOLAN® Folie
CA® Pro+	0.5/0.625/0.75	three-layer, hard-elastic	For moving teeth in the CA® CLEAR ALIGNER system. Compared to single-layer materials, CA® Pro has a more constant force level with low initial force	no		integrated insulation foil

## Expansion parameters of VECTOR® screws

Expansion screw	REF	Expansion per 1/1 turn frontal / transversal	Expansion per ¼ turn frontal / transversal	Total expansion frontal / transversal
VECTOR® 30	2484	0.35 mm	0.0875 mm	3.0 mm
VECTOR® 40	2486	0.7 mm	0.175 mm	3.0 mm
VECTOR® 45	2487	0.7 mm	0.175 mm	3.0 mm
VECTOR® 45 M	2488	0.7 mm	0.175 mm	6.0 mm
VECTOR® 50	2489	0.7 mm	0.175 mm	3.0 mm
VECTOR® 80	2490	0.8 mm	0.2 mm	7.0 mm
VECTOR® 90	2491	0.7 mm	0.175 mm	4.0 mm
VECTOR® 100	2492	0.7 mm	0.175 mm	5.0 mm
VECTOR® 140	2494	0.8 mm	0.2 mm	5.0 mm
VECTOR® 160	2496	0.8 mm	0.2 mm	6.0 mm
VECTOR® 190	2497	0.8 mm	0.2 mm	5.0 mm
VECTOR® 200	2498	0.8 mm	0.2 mm	7.5 mm
VECTOR® 350	2509	0.35 mm	0.0875 mm	4.0 mm
VECTOR® 400	2510	0.35 mm	0.0875 mm	3.0 mm
VECTOR® 420	2512	0.35 mm	0.0875 mm	5.0 mm
VECTOR® 440	2514	0.35 mm	0.0875 mm	5.0 mm
VECTOR® 440R	2513	0.35 mm	0.0875 mm	5.0 mm
VECTOR® 460	2516	0.4 mm	0.1 mm	5.0 mm
VECTOR® 500	2520	0.35 mm	0.0875 mm	3.0 mm
VECTOR® 520	2522	0.35 mm	0.0875 mm	5.0 mm
VECTOR® 600	2524	0.9 mm	0.225 mm	9.0 mm
VECTOR® 620	2526	0.9 mm	0.225 mm	11.0 mm
VECTOR® 720	2530	0.8 / 0.4 mm	0.2 / 0.1 mm	5.5 / 7.0 mm
VECTOR® 730	2532	0.4 mm	0.1 mm	5.5 / 2 x 3.5 mm
VECTOR® 740	2540	0.7 / 0.35 mm	0.175 / 0.0875 mm	2.5 / 5.0 mm
VECTOR® 750	2542	0.35 mm	0.0875 mm	2.5 / 2 x 2.5 mm
VECTOR® 800	2533	0.8 mm	0.2 mm	9.0 mm
VECTOR® 820	2534	0.8 mm	0.2 mm	11.0 mm
VECTOR® 900	2536	0.7 mm	0.175 mm	5.0 mm

## Material list of alloys used by SCHEU-DENTAL (Analysis in Weight-%)

Material	DIN-no.	C	Si	Mn	Cr	Mo	Ni	P	S	Others	Fe	Product Name Product Group
stainless steel	1.4021	0.16 – 0.25	≤ 1.0	≤ 1.5	12.0 – 14.0			≤ 0.040	≤ 0.015			CARAT® / CA®-pliers
stainless steel	1.4116	0.43 – 0.5	≤ 1.0	≤ 1.0	12.5 – 14.5			≤ 0.040	≤ 0.015			CA®-pliers
stainless steel	1.4301	≤ 0.07	≤ 1.0	≤ 2.0	17.5 – 19.5		8 – 10.5	≤ 0.045	≤ 0.015	N ≤ 0.11	rest	SCHEU-Anchor, Clasps/Bars
stainless steel	1.4303	≤ 0.06	≤ 1.0	≤ 2.0	17.0 – 19.0		11.0 – 13.0	≤ 0.045	≤ 0.015	N ≤ 0.11	rest	PROFI-Bar
stainless steel	1.4305	≤ 0.10	≤ 1.0	≤ 2.0	17.0 – 19.0		8.0 – 10.0	≤ 0.045	0.15 – 0.35	N ≤ 0.11 CU ≤ 1.0	rest	Hinge 44, Hinge system acc. to Herbst
stainless steel	1.4310	0.05 – 0.15	≤ 2.0	≤ 2.0	16.0 – 19.0	≤ 0.8	6.0 – 9.5	≤ 0.045	≤ 0.015		rest	CHROMIUM Preformed Wires
stainless steel	1.4456	≤ 0.1	≤ 1.0	16.0 – 20.0	16.0 – 20.0	1.8 – 2.5	≤ 0.2	≤ 0.050	≤ 0.05	V ≤ 0.2 N 0.7 – 1.0	rest	MENZANIUM®
stainless steel	1.4435	≤ 0.03	≤ 1.0	≤ 2.0	17 – 19	2.5 – 3	12.5 – 15	≤ 0.045	≤ 0.015	N ≤ 0.11		TAP® Standard

Material	Co	Ni	Fe	MN	Cr	Mo	Ti	Si	C	Al	O	H	N	V	Cu	Nb	Product Name Product Group
Titan Grade 5			≤ 0.4	≤ 0.1			Rest		≤ 0.08	5.5 – 6.75	≤ 0.2	≤ 0.015	≤ 0.05	3.5 – 4.5			TAP®-T / TAP®-T Reverse Upper protrusion adjustment device
CrCo	62.0 – 66.0				27.0 – 31.0	4.0 – 5.0											TAP®-T Lower guiding device

## Measurement units

mm	Inch	° C	° F	DIN-No.	Material-Name	AISI	UNS
0.10	0.004	10	50	1.4021	X20Cr13	420	S42000
0.15	0.006	25	77	1.4034	X46Cr13	420C	
0.40	0.016	50	122	1.4116	X50CrMoV 15		
0.5	0.020	75	167	1.4035	X46CrS13	420F	
0.6	0.024	100	212	1.4301	X5CrNi18-10	304	S30400
0.625	0.025	125	257	1.4303	X4CrNi18-12	305	S30500
0.75	0.030	150	302	1.4305	X8CrNiS18-9	303	S30300
0.8	0.031	180	356	1.4310	X10CrNi18-8	301	S30100
<b>1.00</b>	<b>0.0394</b>	190	374	1.4456	X8CrMnMoN18-18-2		
1.15	0.045	200	392				
1.30	0.051	210	410				
1.50	0.059	220	428				
2.00	0.079	250	482				
3.00	0.118	280	536				
4.00	0.157	300	572				
5.00	0.197	350	662				
<b>25.40</b>	<b>1.00</b>	400	752				
				bar	at	N / mm <sup>2</sup>	p.s.i.
				1	≈ 1.02	≈ 0.1	14.504
				2	≈ 2.04	≈ 0.2	29.008
				3	≈ 3.06	≈ 0.3	43.511
				4	≈ 4.08	≈ 0.4	58.015
				5	≈ 5.10	≈ 0.5	72.519
				6	≈ 6.12	≈ 0.6	87.023
				7	≈ 7.14	≈ 0.7	101.526

# Product Index

REF	Product	Page	REF	Product	Page	REF	Product	Page
1002	O-Clasp	18	2106	Adams Clasp	24	2542	VECTOR® 750 acc. to Bertoni	35
1003	O-Clasp	18	2107	Adams Clasp	24	3001	BIOSTAR®	116
1007	OK-Clasp	18	2108	Adams Clasp	24	3006	Pellet cover	106
1009	N-Clasp	18	2109	Adams Clasp	24	3007	Pellet cover	106
1010	N-Clasp	18	2118	U-Bar acc. to Karwetzky	25	3011	BIOSTAR®	116
1013	NK-Clasp	18	2288	Triangle Clasp	24	3021	BIOSTAR®	116
1017	J-Clasp	19	2322	Triangle Clasp	24	3134	Model platform	106
1018	J-Clasp	19	2329	Frontal guiding bars acc. to Hinz	25	3135	Sampler of pressure moulding material	101
1019	J-Clasp	19	2330	Frontal guiding bars acc. to Hinz	25	3136	Pellet brush	106
1020	J-Clasp oblique	20	2332	Angle tester acc. to Adamik	45	3147	BIOCRYL® C	88
1021	J-Clasp oblique	20	2419	Coffin spring	25	3148	BIOCRYL® Form X	88
1022	J-Clasp oblique	20	2434	Activator tubes acc. to Teuscher	44	3149	BIOCRYL® C	88
1023	JM-Clasp	20	2436	Activator tubes acc. to Teuscher	44	3150	BIOCRYL® C	88
1026	T-Clasp	19	2470	Activator tubes	44	3151	BIOCRYL® C	88
1027	T-Clasp	19	2471	Activator tubes	44	3152	BIOCRYL® C	88
1029	TK-Clasp	19	2472	Activator tubes	44	3153	BIOCRYL® C	88
1030	TK-Clasp	19	2484	VECTOR® 30	51	3164	IMPRELON®	98
1038	Jaw fracture splint	21	2486	VECTOR® 40 acc. to Prof. Hinz	51	3166	BIOPLAST® Insulating agent	103
1039	PROFI Bar	21	2487	VECTOR® 45 acc. to Prof. Hinz	52	3168	IMPRELON®	98
1040	PROFI Bar	21	2488	VECTOR® 45 acc. to Prof. Hinz	52	3169	COPYPLAST®	99
1047	J-Clasp	19	2489	VECTOR® 50	32	3175	COPYPLAST®	99
1048	J-Clasp oblique	20	2490	VECTOR® 80	32	3177	COPYPLAST®	99
1049	Jaw fracture splint	21	2491	VECTOR® 90	32	3179	COPYPLAST®	99
1051	Lingual bar	21	2492	VECTOR® 100	32	3181	COPYPLAST®	99
1052	Lingual bar	21	2494	VECTOR® 140	32	3183	BIOPLAST®	94
1053	Lingual bar	21	2496	VECTOR® 160	32	3185	BIOPLAST®	94
2040	CARAT® Crampon pliers	30	2497	VECTOR® 190	33	3187	BIOPLAST®	94
2041	CARAT® Flat pliers	29	2498	VECTOR® 200	33	3188	BIOPLAST®	94
2042	CARAT® Young pliers	30	2509	VECTOR® 350	33	3189	BIOPLAST® Insulating agent	103
2043	CARAT® Angle pliers (HM)	29	2510	VECTOR® 400	33	3190	BIOPLAST® bleach	95
2044	CARAT® Aderer pliers large	29	2512	VECTOR® 420	33	3194	HARDCAST®	99
2046	CARAT® Aderer pliers medium	29	2513	VECTOR® 440R	34	3195	HARDCAST®	99
2048	SCHEU-Anchor	24	2514	VECTOR® 440	33	3200	HARDCAST®	99
2049	SCHEU-Anchor	24	2516	VECTOR® 460	34	3202	Spacer foil	100
2050	SCHEU-Anchor	24	2520	VECTOR® 500	34	3203	Coating foil	100
2051	SCHEU-Anchor	24	2522	VECTOR® 520	34	3206	Skin packaging	100
2052	SCHEU-Anchor	24	2524	VECTOR® 600	34	3207	ISOFOLAN®	100
2053	SCHEU-Anchor	24	2526	VECTOR® 620	34	3209	BRUX CHECKER® acc. to Prof. Sato	97
2055	Arrow Clasp	25	2530	VECTOR® 720 acc. to Bertoni	35	3211	Silicone tube	45
2056	Arrow Clasp	25	2532	VECTOR® 730 acc. to Bertoni	35	3214	Cutting bur	108
2100	Security key for expansion screws	36	2533	VECTOR® 800	36	3216	Impression tray handles	105
2101	Key for expansion screws	36	2534	VECTOR® 820	36	3218	BIOCRYL® Resin	103
2104	Adams Clasp	24	2537	VECTOR® 900	36	3220	Blocking-out putty	103
2105	Adams Clasp	24	2540	VECTOR® 740 acc. to Bertoni	35	3221	BIOCRYL® Resin	103

REF	Product	Page	REF	Product	Page	REF	Product	Page
3222	Stainless steel pellets	106	3342	DURASOFT® pd	93	3422	DURAN®+ A2 pd	90
3226	BIOPERM® Trimmer	109	3345	DURASOFT® pd	93	3423	DURAN®+ A2 pd	90
3236	CETRON® Care set	47	3347	DURASOFT® blue pd	93	3424	DURAN®+ A2 pd	90
3237	CETRON® Cleaning powder	46	3348	DURASOFT® blue pd	93	3426	DURAN®+	89
3238	CETRON® Care spray	46	3352	BIOPLAST® Color	95	3428	DURAN®+	89
3239	CETRON® Cleaning powder	46	3353	BIOPLAST® Color	95	3430	DURAN®+	89
3242	OSAMU-Retainer® Kit	98	3354	BIOPLAST® Color	95	3432	DURAN®+	89
3246	OSAMU-Bond	105	3355	BIOPLAST® Color	95	3434	DURAN®+	89
3247	OSAMU Polisher	109	3356	BIOPLAST® Color	95	3436	DURAN®+	89
3256	DURASPLINT® LC	104	3361	IMPRELON®	98	3438	CA® Retention foil pd	51
3257	DURASPLINT®	103	3369	HM-Carbide cutter	108	3440	CA® Retention foil pd	51
3258	DURASPLINT®	103	3370	HM-Tricutter fine	108	3441	CA® Foil	50
3259	DURASPLINT®	103	3371	POLYFIX	109	3442	SIL-KITT	102
3261	DURASPLINT® LC	104	3372	POLYFIX	109	3443	SIL-KITT	102
3263	LC Primer	105	3374	BIOPLAST®	94	3444	Foam discs	105
3265	LC-Bur	108	3376	DIMO®PRO SLIM	109	3445	BIOPLAST® Color	95
3266	LC Insulation	105	3377	Finishing bur	108	3447	MINISTAR S® Protection cover	117
3267	LC-Bur	108	3378	Finishing set	107	3448	BIOPLAST® Color	95
3268	LC-Bur	108	3380	DIMO®	109	3449	BIOSTAR® Protection cover	116
3270	BIOPLAST®	94	3381	DIMO®PRO	109	3452	Heating support	106
3271	BIOPLAST® Color	95	3382	DIMO®	109	3460	SD-Foil scissors A	107
3274	IMPRELON®	98	3383	DIMO®	109	3461	SD-Foil scissors B	107
3282	BIOPLAST® Color	95	3384	DIMO®	109	3470	DURAN®	89
3283	BIOPLAST® XTREME Kit	97	3387	DURASOFT® pd	93	3472	DURAN®+	89
3284	BIOPLAST® XTREME Kit	97	3388	DURASOFT® pd	93	3473	DURAN®+ white pd	90
3285	BIOPLAST® XTREME Kit	97	3390	BIOPLAST® Multicolor	96	3474	DURAN®+ white pd	90
3286	BIOPLAST® XTREME	96	3391	BIOPLAST® Multicolor	96	3475	DURAN®+ white pd	90
3287	BIOPLAST® XTREME	96	3392	BIOPLAST® Multicolor	96	3476	DURAN®+ white pd	90
3288	BIOPLAST® XTREME	96	3393	BIOPLAST® Multicolor	96	3501	MINISTAR S®	117
3289	BIOPLAST® XTREME	96	3394	BIOPLAST® Multicolor	96	3511	MINISTAR S®	117
3292	BIOPLAST® XTREME PRO Kit	97	3395	BIOPLAST® Multicolor	96	3521	MINISTAR S®	117
3293	BIOPLAST® XTREME PRO Kit	97	3396	BIOPLAST® Multicolor	96	3610	DURASPLINT® flex	104
3294	BIOPLAST® XTREME PRO Kit	97	3397	BIOPLAST® Multicolor	96	3611	DURASPLINT® flex	104
3295	BIOPLAST® XTREME	96	3398	BIOPLAST® Multicolor	96	3612	DURASPLINT® flex	104
3296	BIOPLAST® XTREME	96	3399	BIOPLAST® Multicolor	96	3619	DURASPLINT® flex	71
3297	BIOPLAST® XTREME	96	3400	BIOPLAST® Multicolor	96	3620	DURASPLINT® flex	71
3298	BIOPLAST® XTREME	96	3403	COPYPLAST® C	99	3640	CA® Pro	50
3320	IMPRELON® S pd	98	3405	CA® Foil	50	3641	CA® Pro	50
3322	IMPRELON® S pd	98	3406	CA® Foil	50	3642	CA® Pro	50
3324	IMPRELON® S pd	98	3407	CA® Foil	50	3644	CA® Pro+	50
3326	IMPRELON® S pd	98	3409	DURAN®	89	3645	CA® Pro+	50
3328	IMPRELON® S pd	98	3411	DURAN®	89	3646	CA® Pro+	50
3330	IMPRELON® S pd	98	3413	DURAN®	89	5261	CLEAR-BLOKKER®	85
3337	DURASOFT® seal	94	3415	DURAN®	89	5266	Set-up plaster	41
3338	DURASOFT® seal	94	3417	DURAN®	89	5268	Set-up wax rods	42
3339	DURASOFT® seal	94	3419	DURAN®	89	5270	Model holder	118
3341	DURASOFT® pd	93	3421	DURAN®	89	5276	BLUE-BLOKKER®	41

REF	Product	Page	REF	Product	Page	REF	Product	Page
5277	Cannula	102	5373	Saw blades	41	6507	IMPRIMO® LC Cast	68
5278	Cannula	102	5374	Hinge fixator	119	6508	IMPRIMO® LC IBT	68
5281	CA® TIP 1	53	5375	Mounting rails	119	6509	IMPRIMO® LC Gingiva	69
5282	CA® Splint case for patients	57	5376	Hinge fixator	119	6510	3D Model insulation	66
5283	CA® Splint bags	57	5379	Saw blades	41	6515	Asiga MAX™ Tray	64
5288	Diamond separating disc	42	5380	Split-Fixator	119	6516	Asiga MAX™ Tray	64
5290	CA® Coloured pencils	58	5435	Retainer boxes	47	6517	Asiga MAX™ Tray	64
5291	CA® TIP 2	53	5444	Telescopes	74	6518	Asiga MAX™ Tray	64
5292	CA® TIP 3	53	5449	Telescopes	74	6521	Asiga PRO Tray	64
5295	CA® TIP 4	54	5454	Telescopes	74	6523	Asiga PRO Tray	64
5298	CA® Book, volume 1	59	5455	Fastening elements for Herbst appliance	43	6524	Asiga PRO Tray	64
5299	CA® TIP 5	54	5456	Fastening elements for Herbst appliance	43	6525	IMPRIMO® LC Splint flex	67
5300	CA® Pipettes	58	5457	Fastening elements for IST® and Herbst appliances	75	6526	IMPRIMO® LC MJF	70
5301	CA® Plastic buttons	58	5458	Hexagon socket screws	75	6527	IMPRIMO® LC Temp	70
5302	CA® Cyano Veneer Fast	58	5461	IST® Kit HF 9	74	6528	IMPRIMO® LC Temp	70
5303	CA® Travel Case	57	5462	GEORGE GAUGE™ bite fork	83	6529	IMPRIMO® LC Temp	70
5305	CA® Book, volume 1	59	5466	O-Rings for IST® appliance	75	6533	IMPRIMO® Cleaning Liquid	66
5307	CA® Book Advanced, volume 2	59	5468	Fastening elements for IST® appliance	75	6535	RS Cure	65
5308	CA® FLASH	57	5469	Positioning aid for IST® (12° / 0°)	74	6536	RS Wash	65
5309	CA® Book Advanced, volume 2	59	5470	Occlusion trainer	83	6538	Asiga PRO 4K	63
5316	CA® Gauge	56	5471	GEORGE GAUGE™ bite registration set	83	6539	Asiga PRO 4K	63
5319	CA® Distalizer kit acc. to Dr. Echarri	52	5472	GEORGE GAUGE™ bite fork	83	6540	IMPRIMO® LC Denture	69
5323	CA® TIP 6	54	5473	GEORGE GAUGE™ bite fork	83	6541	IMPRIMO® LC Try-In	69
5326	CA® Strip Opener	55	5474	Bite Fix®	82	6542	IMPRIMO® LC Try-In	69
5327	CA® Strip Opener	55	5475	Bite Fix®	82	6543	IMPRIMO® LC Try-In	69
5329	TFA- Kit acc. to Dr. Echarri	52	5478	Hinge system acc. to Herbst	43	6544	IMPRIMO® LC Temp It	70
5338	CA® POWER GRIP set	58	5479	Hinge system acc. to Herbst	43	6545	IMPRIMO® LC Temp It	70
5341	ECHARRI PST Set	56	5480	Hinge system acc. to Herbst	43	6546	IMPRIMO® LC Temp It	70
5342	CA® Stripping Tool	55	5481	Distance rings	43	6547	IMPRIMO® LC Denture	69
5343	CA® Stripping Tool	55	5482	Distance rings	43	6548	IMPRIMO® LC Denture	69
5344	CA® Stripping Tool	55	5483	Distance rings	43	6551	IMPRIMO® Model Separator	66
5345	CA® Stripping Tool	55	5484	Distance rings	43	6552	Tray Box Asiga MAX™	64
5346	CA® Stripping Tool	55	5485	Distance rings	43	7243	RESIMIX®	39
5347	CA® Stripping Tool	55	5489	Fastening elements with retention	44	7244	RESIMIX®	39
5348	CA® Stripping Tool	55	5490	Hinge 44 kit	44	7284	RESIMIX®	39
5349	CA® Stripping Tool	55	5492	Bite Fix® Scan	82	8010	Quad Helix	28
5350	CA® Stripping Tool	55	5493	Bite Fix® Scan	82	8011	Quad Helix	28
5351	CA® Stripping Tool	55	5495	OPM Kit	75	8020	Quad Helix	28
5352	CA® Stripping Tool	55	5503	Bite Fix® One	82	8021	Quad Helix	28
5353	CA® Stripping Tool	55	5610	LC-6 Light Oven	115	8030	Quad Helix	28
5354	CA® Stripping Tool	55	5620	LC-6 Light Oven	115	8031	Quad Helix	28
5358	Stainless steel holder	56	6501	Asiga MAX™	62	8080	Lingual/palatal sheath	28
5359	Splint Remover	59	6502	IMPRIMO® LC Model	67	8081	Lingual/palatal sheath	28
5362	Parallelometer	118	6503	IMPRIMO® LC Splint	67	8130	STEADY-RESIN polymer	39
5368	Set-up wax blocks	42	6504	IMPRIMO® LC Model	67	8131	STEADY-RESIN polymer	39
5371	Set-up trimmer	42	6505	IMPRIMO® LC Model	67	8134	STEADY-RESIN S	37
5372	Set-up manual saw	41	6506	IMPRIMO® LC Impression	68	8135	STEADY-RESIN M	37



REF	Product	Page
8136	STEADY-RESIN S+M	37
8137	STEADY-RESIN S+M	37
8138	Metal spray nozzles	40
8139	Metal spray nozzles	40
8140	STEADY-RESIN VARIO	37
8141	Spray bottle	40
8144	Mica	39
8145	Mica	39
8146	Mica	39
8147	Mica	39
8148	Mica	39
8150	Mica	39
8151	Mica	39
8152	Mica	39
8293	CHROMIUM Wire rods	27
8294	CHROMIUM Wire rods	27
8297	CHROMIUM Wire rods	27
8306	CHROMIUM Wire rods	27
8307	CHROMIUM Wire rods	27
8308	CHROMIUM Wire rods	27
8311	CHROMIUM Wire rods	27
8312	CHROMIUM Wire rods	27
8313	CHROMIUM Wire rods	27
8314	CHROMIUM Wire rods	27
8323	CHROMIUM Coil wire	27
8324	CHROMIUM Coil wire	27
8325	CHROMIUM Coil wire	27
8326	CHROMIUM Coil wire	27
8327	CHROMIUM Coil wire	27
8328	CHROMIUM Coil wire	27
8329	CHROMIUM Coil wire	27
8330	CHROMIUM Coil wire	27
8331	CHROMIUM Coil wire	27
8332	CHROMIUM Coil wire	27
8333	CHROMIUM Coil wire	27
8334	CHROMIUM Coil wire	27
8335	CHROMIUM Coil wire	27
8336	CHROMIUM Coil wire	27
8338	CHROMIUM Coil wire	27
8339	CHROMIUM Coil wire	27
8350	STEADY-RESIN Neon monomer	38
8351	STEADY-RESIN Coloured monomer	38
8352	STEADY-RESIN Coloured monomer	38
8353	STEADY-RESIN Coloured monomer	38
8354	STEADY-RESIN Coloured monomer	38
8355	STEADY-RESIN Coloured monomer	38
8356	STEADY-RESIN Coloured monomer	38

REF	Product	Page
8357	STEADY-RESIN Neon monomer	38
8358	STEADY-RESIN Neon monomer	38
8359	STEADY-RESIN Neon monomer	38
8360	STEADY-RESIN Neon monomer	38
8361	STEADY-RESIN Neon monomer	38
8364	Orthodontic insulating agent	40
8382	CHROMIUM Coil wire	27
8383	CHROMIUM Coil wire	27
8431	Symmetry measurement gauge	45
8435	ECHARRI Template kit	59
8450	Ortho arch bender	30
8453	MENZANIUM® Coil wire	26
8454	MENZANIUM® Coil wire	26
8455	MENZANIUM® Coil wire	26
8456	MENZANIUM® Coil wire	26
8459	MENZANIUM® Coil wire	26
8460	MENZANIUM® Coil wire	26
8461	MENZANIUM® Coil wire	26
8462	MENZANIUM® Coil wire	26
8463	MENZANIUM® Coil wire	26
8464	MENZANIUM® Coil wire	26
8466	MENZANIUM® Coil wire	26
8467	MENZANIUM® Wire rods	26
8468	MENZANIUM® Wire rods	26
8469	MENZANIUM® Wire rods	26
8470	MENZANIUM® Wire rods	26
8471	MENZANIUM® Wire rods	26
8472	MENZANIUM® Wire rods	26
8473	MENZANIUM® Wire rods	26
8478	MENZANIUM® Wire rods	26
8480	MENZANIUM® Wire rods	26
8482	MENZANIUM® Wire rods	26
9000	TAP® Standard	76
9010	TAP® Front assembly	80
9012	TAP3® Closed hook	80
9013	TAP® Lingual bar	80
9014	TAP® Locator	81
9015	TAP® Cover plate	80
9016	TAP® Mounting device	80
9029	TAP®-T XL Lower guiding device	81
9030	TAP®-T	76
9030.2.	TAP®-T	76
9031	TAP®-T Starter-Set	77
9032	TAP®-T Lower guiding device	81
9033	TAP®-T Upper protrusion adjustment device	81
9035	Activation key	85
9037	TAP®-T Matrix	79

REF	Product	Page
9039	TAP®-T Mounting device	79
9050	TAP®-T Reverse	77
9050.2.	TAP®-T Reverse	77
9051	TAP®-T Reverse Starter-Set	77
9053	TAP®-T Reverse Upper protrusion adjustment device	81
9060	dreamTAP™	78
9070	myTAP™	79
9072	AM Aligner	83
9073	TAP® PAP	78
9074	TAP® PAP lower tray	78
9082	TAP® Splint case for patients	79







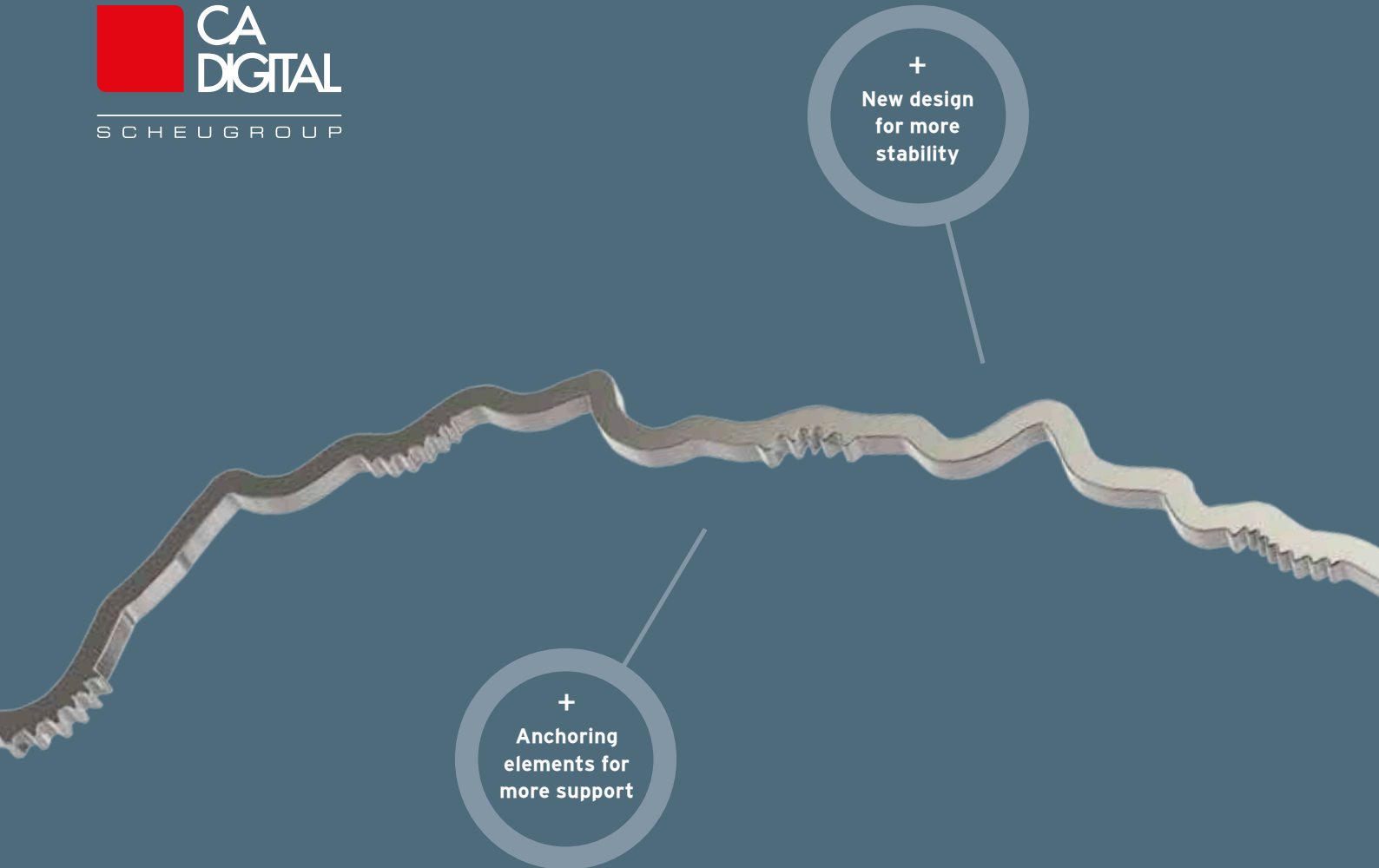

+  
Anchoring  
elements for  
more support

+  
New design  
for more  
stability

**MAXIMUM  
STABILITY\***

# MEMOTAIN 2.0

THE RETAINER THAT KEEPS ITS PROMISES.

+ NEW DESIGN FOR MORE STABILITY + ANCHORING ELEMENTS FOR MORE SUPPORT

**Retention reinvented: minimum risk of breakage - maximum accuracy of fit.**

Improved design, smart anchoring and a breakage rate of 1%\*: MEMOTAIN takes retention to a completely new level. Innovative features such as the selective smoothing of the interdental areas provide additional stability for the retainer. Partial retention elements also ensure more support in the bonding site. Convenient: All new functions are automatically scheduled. Order now and start bonding.

CA DIGITAL – your digital future is just a click away: [www.ca-digit.com/produkte/memotain](http://www.ca-digit.com/produkte/memotain)

\* Statistical data from CA DIGITAL (data sample 30,000 retainer)



More information:

SCHEU-DENTAL GmbH  
[www.scheu-dental.com](http://www.scheu-dental.com)

Am Burgberg 20  
58642 Iserlohn · Germany

phone +49 2374 9288-0  
fax +49 2374 9288-90

**SCHEU**  
SCHEU GROUP

GB 1.500/09/21 REF 0100.02

